

**TVS**  
**NTORQ 125 XT**

**OWNER'S MANUAL**



ALWAYS USE TVS-M GENUINE PARTS

CONTACT(S) FOR SUPPORT	1
UNIQUE Features of TVS NTORQ 125 XT	5
FOREWORD	10
NOTICE	11
SAFETY INFORMATION	12
RUNNING-IN INFORMATION	13
SAFE RIDING TIPS	14
KNOW YOUR TVS NTORQ 125 XT	18
RIDING YOUR TVS NTORQ 125 XT	88
MAINTENANCE	92
WARRANTY AND SERVICES	114
TECHNICAL SPECIFICATIONS	121
EXPRESS SERVICE	124
EXPERT ON WHEELS	125
PICKUP AND DROP	126
GENERAL INFORMATION	127



**Incase you need any Clarification please contact TVS Motor Company Authorised Dealers**

**Or**

**TVS Motor Company's Area Offices (go to subsequent pages for addresses)**

**Or**

**Toll Free Number : 1800-258-7111**

**Email : [customercare@tvs-motor.com](mailto:customercare@tvs-motor.com)**

**Disclaimer :** TVS Motor Company or any of its officials / Authorized Main dealer / Authorized Dealer do not ask customers for bank / card / wallet details / authentication. In case you face any such claim, please report to the relevant local authorities immediately.

## CONTACT AT OUR AREA OFFICES

### TAMILNADU-1, 3 & 4

#### 1. TVS Motor Company Limited

V Floor, Gee Gee Universal,  
No. 2, MC Nichols Road,  
Chetpet, Chennai - 600 031.  
Phone : 044-28361651/28361654  
Email : AO.Chennai@tvsmotor.com  
AO.Madurai@tvsmotor.com

### TAMILNADU-2

#### 2. TVS Motor Company Limited

No. 10, 2nd floor,  
Shree Shanmugapriya Towers,  
Kannuswamy Street,  
Behind Hotel Annapoorna,  
R S Puram, Coimbatore - 641 002.  
Phone : 0422-4350060/2541035  
Email : AO.Coimbatore@tvsmotor.com

### KERALA

#### 3. TVS Motor Company Limited

Ambady Towers, Second Floor,  
Door No. 27/631, A6,  
Edappally-Pookkattupady Road,  
Edappally PO., Cochin - 682 024.  
Phone : 0484-2544578/2556938  
Email : AO.Cochin@tvsmotor.com

### KARNATAKA-1, 2 & GOA

#### 4. TVS Motor Company Limited

No. 600, Anand Surya, 2nd Floor,  
15th Cross, 6th Phase, JP Nagar,  
Opp. BMTC Bus Stop,  
Bangalore - 560 078.  
Phone : 080-26653433  
Email : AO.Bangalore@tvsmotor.com  
AO.Hubli@tvsmotor.com

### ANDHRAPRADESH -1 & 2

#### 5. TVS Motor Company Limited

Rukamani Towers, First Floor,  
No. 3-11-30, Plot No. 11,  
Paigha Colony, Behind Anand Theater,  
Secunderabad - 500 003.  
Phone : 040-27840590/27844419  
Email : AO.Hyderabad@tvsmotor.com  
AO.Vijayawada@tvsmotor.com

### MAHARASHTRA-1 & 2

#### 6. TVS Motor Company Limited

No. 401, 4th Floor, The Chambers,  
Plot No. 4/12/3, Near Ganapati Chowk,  
Viman Nagar, Pune - 411 014.  
Phone : 020-26632111/26632110  
Email : Service.pune@tvsmotor.com

### MAHARASHTRA-3 & CHATTISGARH

#### 7. TVS Motor Company Limited

No. 502B, 6th Floor, B Wing,  
Shriram Shyam Towers,  
Near LIC Square, Sardar,  
Nagpur - 440 001.  
Phone : 0712-2569932  
Email : Service.Nagpur@tvsmotor.com  
AO.Rajpur@tvsmotor.com

### GUJARATH

#### 8. TVS Motor Company Limited

109, Ayna Complex,  
Opp. Suvarna Villa Bungalows,  
100 ft Thaltej Hebbatpur Road,  
Off : S.G. Highway, Thaltej,  
Ahmedabad - 380 054.  
Phone : 079-65443748  
Email : AO.Ahmedabad@tvsmotor.com

**MADHYA PRADESH-1 & 2****9. TVS Motor Company Limited**

No. 211-212, 2nd Floor,  
Chinar Incube Business Centre,  
Chinar Fortune City,  
Near Brindhavan Dhaba,  
Hosangabad Road,  
Bhopal - 462 026.  
Phone : 0755-2499406/2499306  
Email : AO.Bhopal@tvs motor.com  
AO.Indore@tvs motor.com

**RAJASTHAN-1 & 2****10. TVS Motor Company Limited**

Plot No. 17-18,  
2nd Floor of National Motors Building,  
Jhotwara Industrial Area,  
Jaipur - 302 012.  
Phone : 0141-5150901/5150902  
Email : AO.Jaipur@tvs motor.com  
AO.Udaipur@tvs motor.com

**DELHI & HARYANA****11. TVS Motor Company Limited**

D-3 & D-4, 2nd Floor,  
Sector - 10, Noida,  
Uttar Pradesh - 201 301.  
Phone : 011-29834640/29834773  
Email : AO.Delhi@tvs motor.com  
AO.Haryana@tvs motor.com

**PUNJAB & CHANDIGARH****12. TVS Motor Company Limited**

4th Floor, Royal Business Park,  
Chandigarh Ambala Highway,  
Zirkapur - 140 603.  
Phone : 01762-464777/465777  
Email : AO.Chandigarh@tvs motor.com

**UTTAR PRADESH WEST****13. TVS Motor Company Limited**

D-3 & D-4, 2nd Floor,  
Sector - 10, Noida,  
Uttar Pradesh - 201 301.  
Phone : 011-29834640/29834773  
Email : AO.Upw@tvs motor.com

**UTTAR PRADESH CENTRAL & EAST****14. TVS Motor Company Limited**

1st Floor, Cyber Tower, TC-34/N-2,  
Vibhuti Khand, Gomti Nagar,  
Lucknow - 226 010.  
Phone : 0522-4918300/4918301  
Email : AO.Upe@tvs motor.com  
AO.Upc@tvs motor.com

**WEST BENGAL****15. TVS Motor Company Limited**

Ground Floor & First Floor,  
133 A. S. P. Mukherjee Road,  
Opp. Tollygunge Police Station,  
Kolkatta - 700 026.  
Phone : 033-24617096/24617092  
Email : AO.Kolkatta@tvs motor.com

**BIHAR****16. TVS Motor Company Limited**

N-Plaza, Jamal Road,  
P.S. Kotwali,  
Patna - 800 001.  
Phone : 0612-2200068/2200069  
Email : AO.BNJ@tvs motor.com

## ORISSA & JHARKHAND

### 17. TVS Motor Company Limited

No. 303, 3rd Floor,  
Creative Plaza, Rasulgarh,  
Bhubaneshwar - 751 010.  
Phone : 0674-2580019  
Email : AO.Bhubaneshwar@tvsmotor.  
com

## NORTH EAST STATES

### 18. TVS Motor Company Limited

147, Udayan, Ganesh Guri,  
Opp. Punjab National Bank,  
R G B. Road, Guwahati - 781 005.  
Phone : 0361-2202030/2202031  
Email : AO.Guwahati@tvsmotor.com

### 3-VALVE 125 CVTi - Revv ENGINE

Your scooter is India's 1st scooter with 3 valve powerful engine. The additional intake valve in your scooter helps in faster filling of petrol-air mixture and faster & better combustion.

### FULLY DIGITAL CONNECTED INSTRUMENT CLUSTER WITH ON-BOARD DIAGNOSTIC

Your scooter is fitted with 'Fully Digital Connected Instrument Cluster' with hybrid TFT and LCD display screen. This first-in class cluster housed perfectly in the head lamp housing of your scooter. An Engine Malfunction Indication lamp is added to glow whenever there is any fault in the engine.



### SMARTXCONNECT-BLUETOOTH CONNECTIVITY

The connected instrument cluster of your scooter has a inbuilt Bluetooth® connectivity through which you can connect your Android™ smart phone / iPhone® to access the features like caller ID, SMS, missed call notification, navigation in the cluster access and voice assist in the instrument cluster, Ride stats share and last parked location of the vehicle using TVS Connect app. Login to TVS Connect app to explore more SmartXconnect features.

### VOICE ASSIST

Another 1st in market feature - TVS NTOUQ 125 XT is now provided with voice assist. You can use your voice to control various functions like speedometer brightness, vehicle mode etc. You can use your voice through a connected audio device like a Bluetooth® headphone and control vehicle functions like changing modes or starting navigation instructions to a particular location. You can also set location for navigation, current location etc. over voice.



### 'TVS intelliGO' SWITCH\*

An exclusive intelliGO switch is provided to switch 'OFF' and 'ON' the intelliGo system as and when required. Refer page No. 35 for details.



### ECONOMETER®

Your scooter's connected instrument cluster has an 'ECONOMETER®' which indicates whether you are riding in 'Economy Mode' or 'Power Mode'. This is a unique feature of your scooter which guides you to ride your scooter fuel efficiently.



### PASS-BY SWITCH

'Pass-by Switch' allows you to easily switch between high and low beam of head lamp with easy press and auto release. It is helpful especially while overtaking.

The same pass-by switch is used to operate head lamp low / high beam continuous glowing.



### LED HEAD LAMP CUM POSITION LAMP WITH ALL TIME HEAD LAMP ON (AHO)

TVS NTORQ 125 XT comes with premium LED head lamp cum position lamp. Efficient and bright head lamp gives your scooter a totally upgraded look and style with better visibility for night rides.



### EXTERNAL FUEL FILL

This is an exclusive facility which allows you to fill petrol without even getting out of your seat.



### LOW FUEL INDICATOR

'Low Fuel Indicator' is yet another unique feature of your scooter which indicates you to refill the fuel when the fuel in the tank goes below minimum safe level.

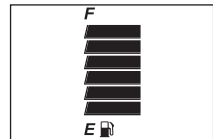

### TEXTURED FLOORBOARD

Your scooter comes with a stylish textured floor board.



### PETAL DISC BRAKE

Your scooter is fitted with '220 mm Roto - Petal Disc' at the front for effective braking and safe riding even at higher speeds.



### LARGER SPORTY ALLOY WHEELS

'Larger Sporty Alloy Wheels' with high mechanical advantage gives progressive braking of your scooter, results in best-in-class 'Shortest Distance' braking. It also provides superior comfort in bad road conditions.



### CHUNKY TUBELESS TYRES

'Chunky Tubeless Tyres' are another important unique feature in your scooter. Tubeless tyres reduces the chances of getting punctured. Even if there is a puncture, sudden leakage of air is avoided, thereby provide better safety and convenience. It is also very easy to repair the punctured tyres.



### PATENTED E-Z CENTRE STAND

'E-Z Centre Stand' of your scooter reduces the effort required to place the scooter on stand.



### RETRACTABLE BAG HOOKS

Your scooter has two retractable 'Bag Hooks' to carry light luggage like carry bags weighing upto 3 kg. One hook is located below the handle bar on the rear panel and the other one is located on the cover front below the front end of the seat.



### LED TAIL LAMP-CUM-BRAKE LAMP

Your scooter has a 'LED Tail Lamp-Cum-Brake Lamp' for better visibility and stylish looks.



### PARKING BRAKE (Rear Brake Lock)

'Parking Brake' is another safety feature which protects your scooter from falling due to wheel rotation when it is parked with the side stand on a slope.



### HAZARD SWITCH

TVS NTORQ 125 XT comes with a hazard switch which can be used whenever it is necessary to park the scooter in a hazardous location due to emergency situation.



### UNDER-SEAT STORAGE (Utility Box)

Your scooter has a 20 litre 'Under-Seat Storage' space to carry your luggage belongings, full face helmet etc.



### SMART PHONE CHARGER

Your scooter has a 'Smart Phone Charger' which enables you to charge your mobile phone even when you are traveling. Use the charger only when the engine running.



### HELMET HOOKS

Your scooter has two 'Helmet Hooks' under the seat assembly at the front end of utility box to secure your helmet.

Your helmets can be hanged in this hooks when the vehicle's utility box is filled with your things.



### ACCESSORIES FOR YOUR VEHICLE

To enhance the look, convenience and safety, the below listed accessories available for your scooter.

Ask your Dealer to fix this accessory on your scooter but it will be charged additional.

- Kickstarter system
- Front glove box
- Beeper
- All round guard
- Floor mat

### Welcome to the NTORQian Tribe!!

If you're reading this. You've chosen to race ahead of the curve.

The TVS NTORQ 125 XT.

A scooter that promises to set your pulse racing with next-gen technology, thrilling performance and a distinctly sporty style.

The latest TVS SmartXconnect technology comes loaded with 60+ features.

From the best interactive tech such as Voice Assist, SmartXtalk, ISS Counter, Traffic Screens to personalisation features that allow for Profile Picture Display, SmartXtrack, Social Media Integration, Ride Reports, Achievements Records to an upgraded navigational experience with Navigatory Voice Commands, Audio Navigation Assist and Graphic Navigation Display on the console with icons, the TVS SmartXconnect technology promises you, a never before seen connected experience thus unleashing a whole new world of connected awesomeness.

The performance features of the TVS NTORQ 125 XT such as the Dual Ride Modes - Street & Sport, 0-60 in 9 Secs and its sporty 3-Valve 125 CVTi REVV Engine is especially designed to thrill and offer a racetrack performance in every ride.

The TVS NTORQ 125 XT features a unique sporty design. The new graphics, Sporty Alloy Wheels, and the exhilarating neon based colour scheme along with the new, stylish UI/UX is designed to bring out the racer in you.

All the features of your new vehicle, along with information on how it operates is available in this manual. This manual is your guide to race ahead of the curve with your new TVS NTORQ 125 XT.

Kindly, read it carefully and follow the instructions to enjoy years of safe and satisfied riding.

And of course, we're sure that a true rider like yourself, will get your TVS NTORQ 125 XT serviced only at TVS Motor Company Authorised Main Dealers or Authorised Dealers at regular periodic intervals.

Now go!

Race ahead of the curve.

**TVS MOTOR COMPANY LIMITED**

Take time to familiarize yourself with your TVS NTORQ 125 XT and its performance characteristics.

This Owner's Manual contains a host of useful information. Please take the time to read this manual before you ride your new TVS NTORQ 125 XT. Get familiarised with the operation of your scooter for maximum safety and pleasure. The better you know your vehicle, the more pleasure you will experience riding your new vehicle. Ensure that anyone else riding your TVS NTORQ 125 XT does the same.

All information, illustrations, photographs and specifications contained in this owner's manual are based on the latest product information available at the time of this publication. TVS Motor Company Limited may, however, incorporate modifications or improvements on its vehicles at any time without notice, and therefore, in such events it is possible that the relevant part of the owner's manual does not apply to your vehicle.

Prior permission of TVS Motor Company Limited is required for quoting, copying or reproducing any part of this owner's manual.

### Note

*Accessories shown in the picture may not be part of the standard equipment. Pictures shown in this manual are of TVS NTORQ 125 XT disc brake version unless specified.*

***TVS NTORQ 125 XT is provided with All time Head lamp 'ON' (AHO). The head lamp glows automatically once the engine is started without activating any other switch.***

***Since your vehicle is fitted with side stand cut-off system ensure to retract the side stand before starting the vehicle.***

Operating this vehicle safely is an important responsibility of the rider. To help you make decisions on safety, we have provided necessary operating procedure and other information in this manual. This information alerts you on potential hazards that could hurt you or others. Since it is not possible to warn you about all the hazards associated with operating or maintaining the vehicle, you must use your own judgement.

You will find important safety information in following form in this manual. These words carry the following connotations:

 **Warning**

*Disregarding this message might result in injury to the rider or deadly accidents.*

 **Caution**

*This message indicates special procedures or precautions to be followed to avoid damage to the vehicle.*

 **Note**

*This message provides further clarification for clear understanding of any particular information.*

The first 1000 km is a crucial part for the life of your scooter. Proper running-in operation during this period helps in ensuring a **maximum life** and **smooth performance** of your scooter.

The reliability and performance of your scooter depends on the special care and restraint exercised during the running-in period. It is especially important that you avoid operating the engine in high speed (RPM), which could expose the engine parts to excessive stress. Maximum recommended speed during the running-in is:

**Maximum 50 kmph speed upto 1000 km** (vary the engine speed for better mating of parts).

**The first free service at 500 ~ 750 km is most important.** During running-in period all the engine components and other parts will have set in. All adjustments to be restored, all fasteners to be tightened. **Engine and transmission oil to be replaced.** Timely performance of the first free service will ensure optimum service life and performance from the engine.

 **Caution**

*Replacing the engine and transmission oil during first free service is most important for better life of engine. Always use TVS TRU4 SKUUTA oil (SAE10W30 API-SL, JASO MB) for better performance and life.*



## SAFE RIDING RECOMMENDATIONS

Any two wheeler riding requires some precautions to be taken to ensure the safety of the rider, pillion rider and other road users. These precautions are:

### Familiarise yourself with new TVS NTORQ 125 XT

Riding skill and your mechanical knowledge forms the foundation of safe riding practices. We suggest you to practice riding TVS NTORQ 125 XT in a low-traffic condition until you are thoroughly familiar with your vehicle and its controls. Remember practice makes you perfect.

### Riding apparel

Loose, fancy clothing can be uncomfortable and unsafe when riding a two-wheeler. Choose good quality two wheeler riding apparel.

### Know your limits

Ride within the boundaries of your own skill at all times. Knowing these limits and staying within them will help you avoid accidents.

### Warning

*Two wheeler safety starts with wearing a good quality helmet. One of the most serious injuries that can happen is a head injury. Always wear an ISI approved helmet that should fit your head comfortably and securely. You should also have good quality goggles to protect your eyes and help your vision.*

*To prevent or minimize accident, never consume alcohol or drugs before or during the operation of your vehicle. Even minimal consumption of these will affect the rider's ability to control the vehicle.*



## Posture

Proper vehicle riding starts with proper posture.

1. Keep your elbows relaxed and flexible.
2. Sit and adjust yourself on seat so that arms and shoulders are relaxed.
3. Look widely instead of gazing at one point.

## Warning

*One-hand riding is dangerous. Keep both hands firmly on the handle bar and both feet securely on the floor board. Under no circumstances should both the hands be removed from the handle bar, as it is very dangerous.*

*Avoid use of mobile phones while riding as it could lead to fatal accident.*

*Slow down to a safe speed before negotiating a corner. If this is the first time that you are riding a vehicle of this type, we suggest that you practice on a safe, open area to thoroughly familiarise with the operation of the vehicle.*

## Cornering

When cornering, centrifugal force works in a direction perpendicular to the direction in which the vehicle is moving. Centrifugal force increases in proportion with speed and the radius of the corner.

During cornering, reduce speed so as to lessen the effects of centrifugal force. By all means, avoid abrupt application of brake or sudden steering.

## Braking

For safe riding, it is very important to master the braking techniques.

1. Close / release the throttle.
2. Hold the vehicle upright as you apply the brake.
3. Progressive application of brakes is safer.
4. **Apply both the brakes. 'SBS' provides additional braking even when 'Only Rear brake' is applied, But applying 'Both the brakes' helps you to use the full potential of the brakes.**
5. Riding down hills, while cornering and wet roads, close throttle and come to a slower speed to avoid the loss of control over the vehicle due to skidding.

## Causes for poor braking

1. If the brake shoes / pads or drum / disc are worn out or if there is water or oil on them, sufficient friction does not develop and brakes do not work well.
2. Even when the brake works normally, if the road surface is wet or the tyre surface is worn-out, tyres do not take a firm hold on the surface, increasing the stopping distance.
3. Approximately 60% braking effect is from front brake. **Non-usage of front brake causes poor braking.**

## Warning

*As the vehicle speed increases, the stopping distance also increases progressively. Be sure that, you have sufficient distance between you and the vehicle or obstruction ahead of you.*

*Using only the front or rear brake is dangerous and can cause skidding and loss of control. Apply both the brakes together and with great care on a wet road or other slippery surfaces. Any abrupt braking on slippery or irregular roads can cause loss of rider control.*

## ACCESSORY INSTALLATION AND SAFETY TIPS

Use extreme caution while selecting and installing the accessories for your scooter.

The addition of **unsuitable accessories can lead to unsafe operating conditions.** Your friendly Dealer will assist you in selecting quality accessories and installing them correctly.

While selecting the accessories, make sure that the accessories **should not obstruct lighting, steering, suspension level and ground clearance.**

**Additional electrical equipment is not acceptable as it will void the warranty terms of the vehicle.**

## EMISSION CONTROL

All the TVS vehicles are tested in the factory for optimum fuel efficiency and CO levels. If the vehicle needs any adjustments, please consult nearest TVS Motor Company Authorised Main Dealer or Authorised Dealer.

While adequate care is exercised at the factory to ensure that the emissions are within the limits, it is essential for the owner to always maintain the scooter in good condition by getting it periodically checked and serviced by TVS Motor Company Authorised Main Dealer / Authorised Dealer so that the emission and fuel consumption levels are maintained as per norms.

### **Crankcase emission control system**

The engine of new TVS NTORQ 125 XT is equipped with a closed crankcase system to prevent discharging crankcase emissions into the atmosphere. Blow-by gas is returned to the combustion chamber through the air cleaner and the fuel system.

### **Evaporative Emission Control System**

TVS NTORQ 125 XT is equipped with an evaporative emission control system which consists of a canister and associated piping. This system prevents the escape of fuel vapors from the fuel tank.

### **Warning**

*If there is any abnormal jerk, startability issue are felt in the vehicle or noise due to sudden escape of gas during opening of fuel tank cap, immediately report to the TVS Motor Company Authorised Main Dealer / Authorised Dealer.*

### **Note**

***Your vehicle is tested and certified for emission which meets BSVI emission norms and is valid for initial 12 months from the date of purchase. Get your vehicle certified by the Government authorised emission testing station after initial 12 months of usage. And ensure to get the vehicle certified on expiry of the certificate obtained.***

***Fill fuel to the marked reference as mentioned in warning sticker, to ensure proper functioning of Evaporative Emission Control system.***

### VEHICLE IDENTIFICATION NUMBER

The frame and engine serial numbers are the only means of identifying your vehicle from others of the same model and type. They are also required to assist your Dealer for ordering parts or referring to special information.



The frame serial number is stamped on the frame, at the rear end below the seat assembly. Open the seat assembly to read the frame number.



The engine serial number is stamped on the left side of the engine, at the bottom, near center stand mounting. See bottom to read serial number.

## LOCATION OF PARTS - HANDLE BAR

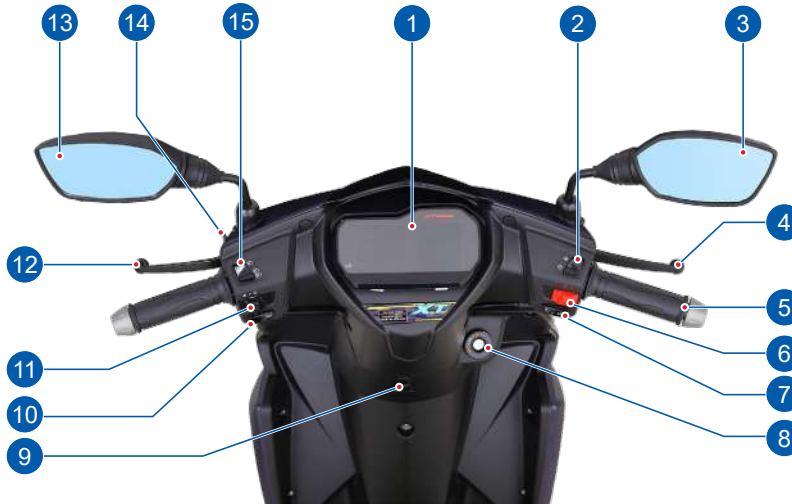

1. Connected instrument cluster
2. 'TVS intelliGO' switch
3. Rear view mirror R
4. Right hand brake lever
5. Throttle grip
6. Hazard switch
7. Electric start / voice assist switch
8. Ignition cum steering lock
9. Bag hook (front)
10. Horn switch
11. Turn signal lamp switch
12. Left hand brake lever (SBS)
13. Rear view mirror L
14. Parking brake (rear brake lock)
15. High/low beam cum pass by switch

## LOCATION OF PARTS - VEHICLE LEFT SIDE



1. Disc plate front
2. Front wheel axle
3. Caliper assembly front
4. Side stand
5. Pillion foot rest L
6. Rear brake adjuster nut
7. Lady foot rest - foldable<sup>#</sup>
8. Seat cum fuel tank lock

<sup>#</sup> Mandatory accessory will be charged extra

**LOCATION OF PARTS - VEHICLE RIGHT SIDE**

1. Seat assembly
2. Muffler assembly
3. Gauge oil level
4. Pillion foot rest R
5. Cover front
6. Bag hook (rear)
7. Front wheel axle nut



## LOCATION OF PARTS - VEHICLE FRONT & REAR



### FRONT

1. Head lamp assembly
2. DRL
3. Turn signal lamp front R
4. Turn signal lamp front L

### REAR

1. Tail / brake lamp
2. Turn signal lamp rear R
3. License plate lamp
4. Transmission oil level screw
5. Turn signal lamp rear L
6. Pillion handle

*License plates are mandatory accessory will be charged extra*

## CONTROL KEY

TVS NTORQ 125 XT comes with a pair of identical control keys. These keys are to operate ignition cum steering lock, fuel tank cap and seat lock.

### IGNITION CUM STEERING LOCK

The ignition lock enables and disables the electrical circuit and steering lock. The three positions of the lock are described below.

#### 1. 'OFF' position

All the electrical circuits are turned 'OFF' in this position. Engine will not start. Key can be taken out.

#### 2. 'ON' position

In this position, all the electrical circuits are turned 'ON' and the engine can be started now. Key cannot be removed in this position.

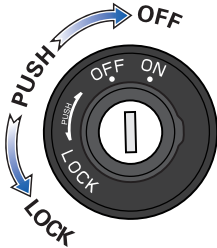

The connected instrument cluster and warning lights perform the self-diagnostic cycle once upon activation.

#### 3. 'LOCK' position

TVS NTORQ 125 XT steering can be locked in both 'left' and 'right' directions.

Turn the handlebar to the 'left' or 'right'. Press the key 'IN' and rotate it to the 'LOCK' position from 'OFF' position. All electrical circuits are deactivated and the steering is locked. The control key can be removed from the lock.

**Insert the key into the lock and press the key 'IN' and turn it to 'OFF' or 'ON' position to unlock the steering.**

#### Note

*When you switch on the key, the pump priming noise may be heard which is normal. Avoid frequent 'SWITCH-OFF & ON' of the ignition key to avoid unnecessary run of fuel pump.*

*By default when the scooter is switched 'ON' for the first time it starts with the 'Street Mode'.*

## Warning

Never attempt to move the vehicle when the steering is locked, you may lose balance.

## Caution

Leaving the ignition cum steering lock in 'ON' position for a prolonged time will drain the battery when the vehicle is not in use. Switch 'OFF' and take the control key out when the vehicle is not in use.

Always lock the steering while parking for safety.

## Note

The connected instrument cluster background illumination, day time running lamp (DRL) and tail lamp glow automatically once the ignition key is turned 'ON' without activating any other switches.



When the ignition switch is turned 'ON', the connected instrument cluster performs a self diagnostic cycle and welcome screen animation for 5 second. **Wait till the message 'HI RIDER' or name of the person and the profile picture which is uploaded in the app is displayed in the connected instrument cluster's TFT display.**

## HANDLE BAR LEFT SIDE

### 1. Horn switch

Press the switch '' to operate the horn.

### 2. Turn signal lamp switch

Slide the turn signal lamp switch to left '' or right side '' to operate respective turn signal lamps (LH / RH). Press the center button of the switch to turn 'OFF'.



## Warning

Always use the appropriate turn signal lamps when you intend to change lanes or take turns. Be sure to switch it 'OFF' after negotiating the lanes or turns.

### 3. Left hand brake lever (SBS brake lever)

Synchronised Braking System (SBS) can be operated by pressing the left hand brake lever gently towards the handle grip. SBS technology helps to operate both front and rear brakes by distributing the force optimally between the two braking system.

### 4. Rear brake lock lever

Rear brake lock protects your vehicle from rolling-off, when parked on a side stand (or) helps you to relax while waiting in a long traffic signal (or) a slope.

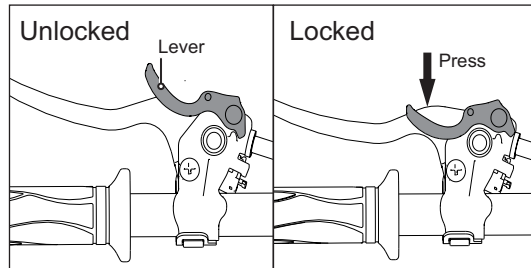



#### **Warning**

Since your vehicle is fitted with SBS brake system it is essential to maintain the brake system in good condition. Adjust the brakes system at regular intervals for the proper working of SBS.

To activate the rear brake lock, press the brake lever almost half towards the grip and hold, then press the rear brake lock to the maximum and release the brake lever slowly. Finally ensure the brake is locked properly. Pressing the brake lever further releases the brake lock automatically.

### 5. High/low beam cum pass by switch

With the head lamp 'ON' (the head lamp gets on automatically once the engine is started), press the switch towards '  ' to operate head lamp high beam or press it towards '  ' to operate head lamp low beam.

TVS NTORQ 125 XT has a combined switch for head lamp 'high / low' beam and pass by.

To operate the pass by, keep the switch in 'low beam' position, press gently and release. This makes the head lamp high beam to flash and signal the approaching vehicle. The pass by signal can be used while overtaking during day time.

#### **Warning**

Ensure to release the brake lock before riding the vehicle.

Use appropriate head lamp beam 'high / low' as per the traffic and road conditions for your safety and avoid inconvenience to other riders.

## HANDLE BAR RIGHT SIDE

### 1. Right hand brake lever

The right hand brake lever controls a hydraulic circuit of the brake system. While squeezing brake lever the hydraulic circuit operates the front brake system and applies the brake. The brake lamp glows on application of front brake.

### 2. Throttle grip

Engine speed is controlled by the rotation of the throttle grip. Twist it towards you to increase the engine speed and twist it away from you or release it to decrease the engine speed.

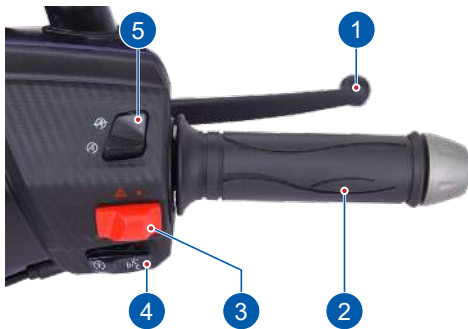

### 3. Hazard switch

Whenever it is necessary to park the scooter in a hazardous location due to emergency situation, press the hazard switch to '▲' position with the ignition 'ON' condition. This makes all the turn signal lamps to flash simultaneously to make other road users aware of presence of the vehicle.

#### Warning

*Usage of hazard switch in engine 'OFF' condition can lead to battery drain and can affect the electric startability of the vehicle.*

### 4. Electric starter / Voice assist switch

Retract the side stand and press the starter switch '⊗' to start the engine electrically along with the application of either front or rear brake.

The same switch can be used to activate the voice assist '🗣️'. Single tap or long press of the switch activates the voice control when your smart phone is connected with your instrument cluster via Bluetooth.

#### Note

*Voice assist will be activated only when there is an audio device connected with your mobile phone and paired with 'TVS Connect App'. Audio device can be connected via. wired or wireless Bluetooth headphone.*

## 5. 'TVS intelliGO' switch

To activate the 'TVS intelliGO' system, set the intelliGo switch to 'A' position. The intelliGo indicator 'A' of the speedometer glows for 2 seconds.

To deactivate 'TVS intelliGO' system, set the intelliGo switch to 'A' position.

### Note

Refer page No. 27 for intelliGo feature details.

## CONNECTED INSTRUMENT CLUSTER

Your TVS NTORQ 125 XT is provided with a fully digital connected instrument cluster with lots of features and various modes like 'STREET' mode, 'SPORT' mode, mobile app for Android™ / iOS devices, caller profile image display, voice assistant and navigation assist etc.

Once the ignition is turned ON, there will be an intro animation for 5 seconds.



## 1. Economy and power indicator

Eco indicator (green lamp) indicates that the vehicle is running in economy mode which gives better fuel economy.

Power indicator (amber lamp) indicates that the vehicle is running in power mode.

### Note

*Always ride the vehicle in 'Economy Mode' for better fuel efficiency.*

*Whenever the engine is kept running in idle mode for more than 20 seconds approximately, the power mode indicator blinks and informs you that the fuel is getting wasted, please turn on intelligo feature or the engine needs to be switched 'OFF' to save the fuel. The power mode indicator blinking (power mode) changes to green light glowing (economy mode) when the throttle position is changed / increased from idling.*

## 2. Side stand indicator

The side stand warning indicator turns 'ON' to alert you whenever the vehicle's side stand is deployed (vehicle parked condition).

### Note

*If the side stand is deployed, the vehicle will not start. Retract the side stand to start the vehicle.*

*If there is an error in the side stand sensor the indication will not blink and the vehicle will not start. In such a condition, please visit the nearest TVS Motor Company Authorised Main Dealer / Authorised Dealer.*

## 3. ISG malfunction indicator

ISG malfunction indicator will be turned 'ON' when the ISG detects a fault in the system. If the ISG malfunction indicator is glowing continually after the self check of the connected instrument cluster, immediately contact the nearest TVS Motor Company Authorised Main Dealer / Authorised Dealer.

## 4. Turn signal indicator left

Flashes when the 'left' side turn signal indication is activated.

## 5. High beam indicator lamp

Glowes when the head lamp is activated in high beam or pass-by condition.

## 6. Turn signal indicator right

Flashes when the 'right' side turn signal indication is activated.

## 7. 'TVS intelliGO' indicator

Fuel is consumed unnecessarily when the engine is in idling (e.g. In traffic signals) as there is no useful output to the wheel. It contributes to emission and decreases mileage of the vehicle considerably.

To overcome this issue 'TVS intelliGO' system is introduced in TVS NATORQ 125 XT to automatically shut down the engine when it is kept idling for long and restart from stop condition by simply pressing the Brake and giving Throttle. The vehicle also can be restarted using 'Electric start' if required. **Use of this 'TVS intelliGO' system improves the fuel economy and reduces emission.**

### Activation of 'TVS intelliGO' system:

'TVS intelliGO' system gets activated when the following requirements are satisfied,

1. 'TVS intelliGO' switch is in 'A' position
2. Engine is warmed up and
3. When the vehicle speed is more than 5 kmph

When the vehicle has met the above conditions, the 'TVS intelliGO' system gets enabled and the intelliGO indicator 'A' in the speedometer glows and informs you that the vehicle has entered 'intelliGO' loop and the engine will stop automatically at upcoming vehicle idling condition.

Once the vehicle enters the idling condition, the intelliGO indicator starts blinking instead of glowing and engine stops after predetermined time. The connected instrument cluster's TFT display will show time remaining to enter fuel saver mode (IntelliGO stop mode).

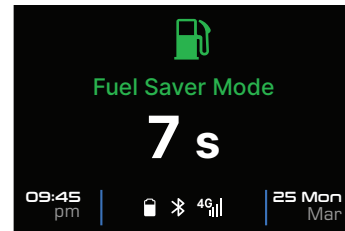

The intelliGO indicator starts glowing during the engine stop to indicate you that the vehicle has stopped due to 'intelliGO' system.

When the vehicle is stopped by the 'TVS intelliGO' System the connected instrument cluster's TFT display the traffic screens. Refer page No. 52 for details.



**The vehicle stopped by 'TVS IntelliGO' system can be restarted at any time within 5 mins from the stop of the vehicle by IntelliGO feature in a simple way of applying Brake and Throttle blip.**

**Deactivation of 'IntelliGO' system:**

'Idle start stop' system will be deactivated if the IntelliGO switch is positioned at '' position.

If the ISG malfunction indicator or MIL indicator is 'ON' then the IntelliGO system will not work not get activated.

If there is 5 unsuccessful start of the vehicle either by electric start or by IntelliGO restart method in one ignition key 'ON' cycle then the IntelliGO will not get activated.

If vehicle is not restarted within 5 mins from idle stop, then IntelliGO will be deactivated.

**Prolonged idling:**

When vehicle is in idling with the engine temperature high enough to maintain stable engine idling rpm and the IntelliGO switch is in '' position, then the IntelliGO will be activated.

When 'TVS IntelliGO' is enabled, the IntelliGO lamp glows for 5 seconds and then blinks for predetermined time and then the engine stops.

IntelliGO lamp will glow after vehicle has stopped due to this feature. By applying Brake and Throttle blip the engine can be restarted again.

 **Note**

*Ensure that the brake free play is adjusted and it is within the limit for the proper working of 'TVS IntelliGO'.*

*Vehicle can be started at any point of time using 'electric start' when the engine is stall condition and the ignition key is in 'ON' condition. The 'TVS IntelliGO' switch can be activated / deactivated at any point of time.*

*If vehicle is stopped by 'TVS IntelliGO' system, and the 'TVS IntelliGO' switch is toggled from 'ON' to 'OFF' and back to 'ON', the IntelliGO system will be deactivated and the vehicle can be restarted only by the 'electric start'.*



## 8. Low fuel indication ( )

The low fuel indicator glows when the fuel level goes down and a warning message 'Low fuel' will be displayed continuously in the connected instrument cluster's TFT display for your attention.



### Caution

When the low fuel warning indicator lamp glows, fill the fuel immediately to avoid engine switch 'OFF' / damage to fuel pump which leads to replacement of pump without warranty.

## 9. Malfunction indicator lamp - MIL ( )

MIL is turned 'ON' when the ECU detects a fault in the EFI system.

If the malfunction indicator lamp ' ' is glowing continually even after starting the engine, immediately contact the nearest TVS Motor Company Authorised Main Dealer / Authorised Dealer.

### Note

The malfunction indicator will continue to remain switched 'ON' after self checking of cluster until the engine is started. But soon after starting the engine this indicator gets 'OFF' if there is no malfunction is detected in the system.

## Mode and Set buttons

MODE button is used to change the connected instrument cluster's display to various modes like 'Street mode', 'Sport mode', 'Ride stats mode', and to view battery voltage, clock, date, brightness adjustment setting and Bluetooth pairing etc.



SET button is used to 'Set' or 'Erase the stored value' in various modes.

The SET button is also used to find the estimated time of arrival, clock setting, Bluetooth pairing etc.

When the MODE button in the instrument cluster is pressed, the mode change will happen i.e. when the display is in Street mode, if the MODE button is pressed, it will change to Sport mode and the vice-versa is also applicable.

The mode change via instrument cluster using MODE button is possible even when the engine is in 'OFF' condition.

If the vehicle speed crosses 2 kmph, then mode change will not be possible using MODE button. Street and Sport modes can be changed through voice assist from Street to Sport mode and vice-versa even when the vehicle is running if the instrument cluster is connected via Bluetooth.

TVS NTORQ 125 XT's connected instrument cluster offers you different modes of display to choose.

1. Street mode
2. Sport mode
3. Battery voltage
4. Ride stats mode
5. BT pair mode
6. Set clock mode
7. Set date mode
8. Adjust Brightness
9. Information

In the above list, Street and Sport modes are ride modes.

The sequence of modes, their selection and their working is explained in the following pages.

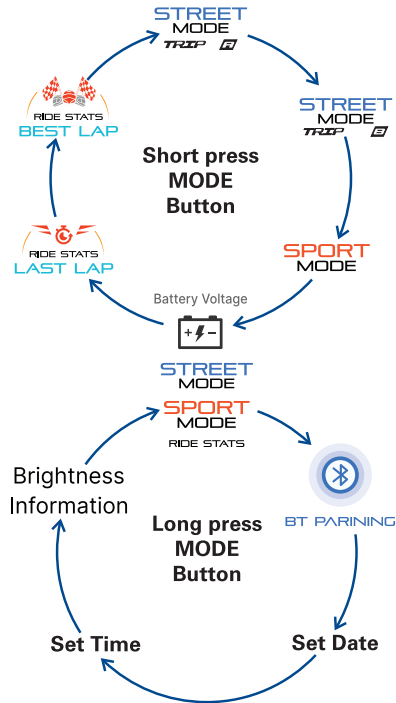

## Note

Only Street mode and Sport mode will be displayed in the instrument cluster during vehicle run. All other modes can be accessed only when the vehicle is static.

On ignition 'OFF' and 'ON', the previously displayed mode will be retained in display of the connected instrument cluster.

The connected instrument cluster of your scooter enters into BT pair mode automatically, when the following conditions are met:

1. Battery is disconnected and reconnected again.
2. When the vehicle fuse is blown and replaced.
3. When the electric start is done with the low SOC (state of charge) battery (will be indicated through self-check of connected instrument cluster).

## 1. Street mode

In street mode, there is an intro animation while entering. The following features will be displayed on the connected instrument cluster's TFT display:

- 1a. Digital clock
- 1b. Smart phone info
- 1c. Date
- 1d. ECO - PWR %
- 1e. Riding since

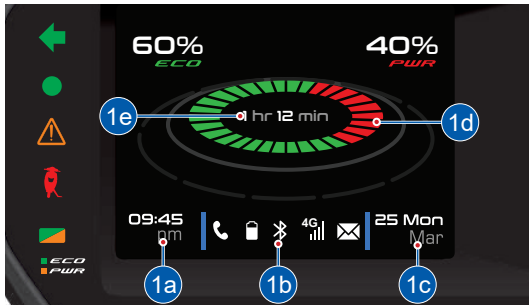

### 1a. Digital clock

Indicates the time in 12 hour format (AM or PM).

**09:45**  
am

### 1b. Smart phone info

'Smart phone info' displays your smart phone's Bluetooth, battery level, network providers signal strength, missed call and message alerts when the instrument cluster is connected via Bluetooth.



### 1c. Date

Indicates the date in day and month format.

**25 Mon**  
Mar

### 1d. ECO - PWR %

This function shows the percentage of distance that the vehicle has been driven in 'economy' and 'power' mode with respective to ride pattern and duration of travel.

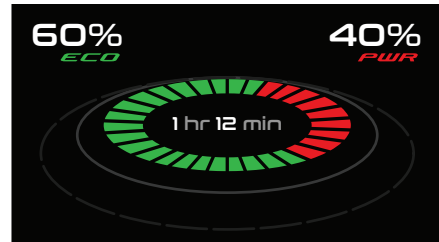

### 1e. Riding since

Riding since will display the duration of travel in Street / Sport mode.

**1 hr 12 min**

The following features will be displayed on the connected instrument cluster's LCD display:

- |                     |                           |
|---------------------|---------------------------|
| 1f. Odometer        | 1g. Helmet icon           |
| 1h. Speedometer     | 1k. Low battery indicator |
| 1m. Fuel gauge      | 1n. Service reminder      |
| 1p. Trip A, B and F |                           |



### 1f. Odometer

Odometer registers the total distance covered by the vehicle in kilometer.

**Odo**  
**4628 km**

### 1g. Helmet icon

With every ignition 'ON', helmet icon  blinks for 10 seconds to remind the rider to wear a helmet.

### Note

*Helmet icon indicator works in all the modes of connected instrument cluster.*

### 1h. Speedometer

Indicates the vehicle speed in kilometer per hour by default when the ignition is turned 'ON'.

**45**  
**km/h**

### 1k. Low battery indicator

An icon with battery symbol '⎓' glows when the battery charge of the vehicle is too low and the message 'vehicle battery low' will be displayed in TFT display of the instrument cluster. Get the battery checked at TVS Motor Company Authorised Main Dealer / Authorised Dealer.



### Note

*Low battery indicator works in all the modes of the connected instrument cluster.*

### 1m. Fuel gauge

Digital bars indicates the approximate quantity of fuel available in the fuel tank. There are six bars to indicate the quantity of fuel available in the tank.



All the six bars will be displayed when the fuel in the tank reaches above 5 litres approximately (full tank). When the fuel reaches half tank (3.2 litres approx.) the fuel gauge displays only three bars as shown.



When the fuel reaches minimum safe level (1.2 litres approx.), the last bar of the fuel gauge starts blinking and low fuel indicator starts glowing.



The message 'Low fuel' will be displayed in TFT display and 'Trip F' meter starts counting from 0.0 km as explained in page no. 38.



### Note

Fuel level shown is only for reference purpose and users are not encouraged to calculate mileage of the vehicle using the same. If all the fuel level bars of the connected instrument cluster starts blinking and an error message 'Check fuel sensor' displayed in the TFT display, Contact nearest TVS Motor Company Authorised Main Dealer / Authorised Dealer.



### 1n. Service reminder

If the service is due, whenever the ignition is turned 'ON', a icon with spanner symbol ' blinks for 10 seconds after the self-check cycle of connected instrument cluster and continue to glow till the vehicle is serviced and the reminder is reset. Get the vehicle serviced at TVS Motor Company Authorised Main Dealer / Authorised Dealer.

The message 'Due for service' Due for service will be displayed in TFT display.



### Note

Service reminder works on all the modes of the connected instrument cluster. Service reminder indicator lamp glows before a day of service due date.



### 1p. Trip A and B

Trip meter indicates the trip distance traveled in kilometer. The digit after the dot mark denotes one tenth of a kilometer.



Provision is provided for the users to measure two different distances as per their convenience. In street mode, 'TRIP A' will be displayed by default. Press mode button once to enter 'TRIP B'. To reset any of the trips (A or B), press the 'SET' button more than 3 seconds while display is in the respective trip when the vehicle is in static condition.

### Trip F



This function shows the distance traveled after the low fuel indication symbol (  ) is 'ON' and 'Low fuel' message displayed in the TFT display. The display switches automatically to 'TRIP F' once the low fuel indication is 'ON' and starts counting from 0.0 km.

If the fuel level remains in minimum safe (reserve) level, the reading will be saved even after the ignition 'OFF'.

The 'Trip F' meter stops counting and gets cleared automatically once the fuel is filled above minimum safe (reserve) level which is indicated by at-least 2 bars in the fuel gauge. Once 'Trip F' is cleared, Trip A / B display switches 'ON' automatically.

**Please remember that the 'Trip F' meter cannot be activated or deactivated manually and can't be reset.**

On every ignition 'ON', 'Trip F' meter will get enabled automatically until fuel level raises above minimum safe level. 'Trip A' and 'Trip B' will still be accessed by short pressing the 'MODE' switch but the display will automatically enter 'Trip F' after 5 seconds.

## 2. Sport mode

To enter into 'Sport mode', short press the 'MODE' button in 'Street mode' while 'Trip B' in display. In 'Street mode', there is an intro animation.

The following features will be displayed on the connected instrument cluster in TFT display when the display is in 'Street mode':

- 2a. Digital clock
- 2b. Riding since
- 2c. Date
- 2d. RPM

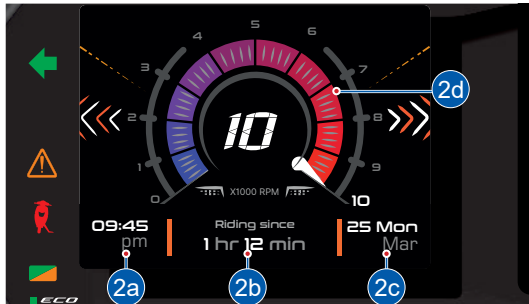

### 2a. Digital clock

Indicates the time in 12 hour format (AM or PM).

**09:45**  
am

### 2b. Riding since

Riding since will displays the duration of travel in 'Street / Sport' modes.

Riding since  
**1 hr 12 min**

### Note

*Riding since will not be displayed once the Bluetooth is connected.*

### 2c. Date

Indicates the date in day and month format.

**25 Mon**  
Mar

### 1d. RPM

RPM indicates the engine speed in multiples of 1000 RPM (Revolutions Per Minute).

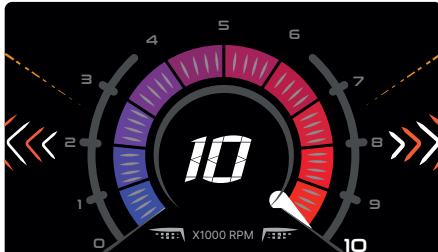

The following features will be displayed on the connected instrument cluster in TFT display when the display is in 'Street mode':

- 2e. Speedometer (refer page no. 35)
- 2f. Fuel gauge (refer page no. 36)
- 2g. Shortest time indicator
- 2h. Lap distance
- 2k. Lap timer

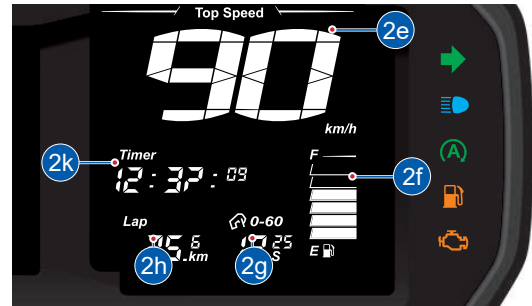

### Note

One lap is considered from one ignition 'ON' to 'OFF'.

## 2g. Shortest time indicator



Shortest time indicator records the minimum time taken to reach 60 km/h from start. The timer starts once the vehicle speed crosses 2 km/h and the time will be displayed on crossing 60 km/h speed.

### Note

*The value of shortest time indicator disappears automatically if the vehicle speed reduces below 2 km/h.*

*Shortest time indicator data will be displayed only if the time taken to reach 0 to 60 km/h is less than 15 seconds. If the time taken is more than 15 seconds then the default time (15 seconds) will be displayed.*

*The values of Sport mode can be reset by pressing 'SET' button for more than 3 seconds in vehicle static condition only.*

## 2h. Lap distance



The total distance covered by the vehicle in a particular lap will get captured in 'Lap distance' counter. Once the vehicle speed crosses 2 km/h, the lap distance counter starts counting distance automatically and stops when the speed goes below 2 km/h. If the speed increases again, the counter continues the distance counting. The lap distance counter ends when the ignition is turned 'OFF'.

## 2k. Lap timer

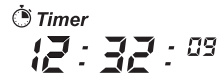

Lap timer is the total time taken by the vehicle for completing a single lap.

Similar to lap distance, the lap timer also starts once the vehicle speed crosses 2 km/h and stops when the speed goes below 2 km/h indicated by blinking of lap timer '' icon. If the speed increases again, the timer continues counting. The lap timer ends when the ignition is turned 'OFF'.

### 3. Battery voltage

The connected instrument cluster displays the actual battery voltage of the vehicle.

To view battery voltage, short press the 'MODE' button in Sport mode when the vehicle is static.



#### Note

*If the battery voltage is low, take your vehicle to nearest TVS Motor Company Authorised Main Dealer / Authorised Dealer.*

### 4. Ride stats mode

To enter into ride stats mode, short press the 'MODE' button in battery voltage mode when the vehicle is static.

Following two features are available in ride stats mode.

#### 4.1. Ride stats last lap

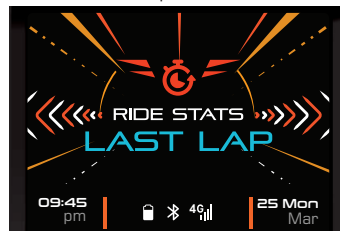

#### 4.2. Ride stats best lap

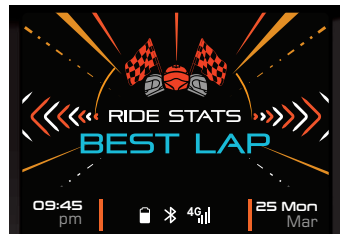

## Note

In this mode, if the vehicle speed crosses above 2 km/h, the connected instrument cluster enters to 'STREET MODE' automatically.

### 4.1. Ride stats last lap

There is an intro animation. The following features will be displayed on the connected instrument cluster in LCD display when the display is in 'Ride stats last lap':

'Ride stats last lap' appears by default on entering ride stats mode. The details displayed in this mode are as given below :

- 4.1a. Previous Sport top speed
- 4.1b. Previous Sport shortest time
- 4.1c. Previous Sport timer
- 4.1d. Previous Sport distance

#### 4.1a. Previous Sport top speed

Previous Sport top speed is the top speed that the vehicle has achieved during last lap.

#### 4.1b. Previous Sport shortest time

Previous Sport shortest time is the shortest time taken to reach 0 to 60 km/h in the last lap. If there are more than one record in the same lap, the best value will be displayed.

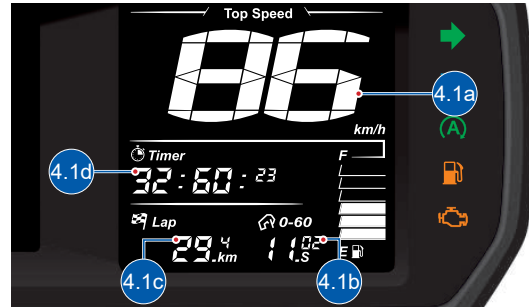

#### 4.1c. Previous Sport lap distance

Previous Sport lap distance is the total distance covered by the vehicle in the last lap.

#### 4.1d. Previous Sport lap timer

Previous Sport lap timer is the total time taken by the vehicle to complete the last lap.

## Note

All the above details are recorded only when the vehicle is driven in Sport mode. All the above values can be reset by pressing the 'SET' button for more than 3 seconds in vehicle static condition.

## 4.2. Ride stats best lap

To enter 'Ride stats best lap' mode, press 'MODE' button once in 'Ride stats last lap'.

There is an intro animation. The following features will be displayed on the connected instrument cluster in LCD display in 'Ride stats best lap' mode:

- 4.2a. Best top speed
- 4.2b. Best shortest time
- 4.2c. Best lap distance
- 4.2d. Best lap timer

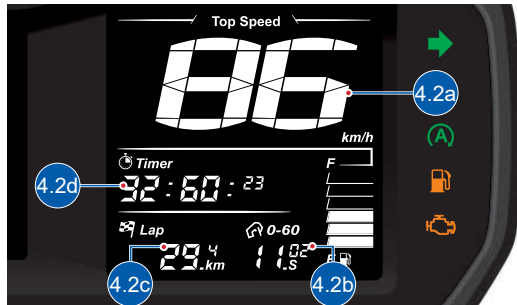

### 4.2a. Best top speed

'Best top speed' is the highest speed that the vehicle has reached since the time of vehicle purchase or since last reset.

### 4.2b. Best shortest time

'Best shortest time' is the shortest time taken ever to reach 0 to 60 km/h speed since the time of vehicle purchase or since last reset.

### 4.2c. Best lap distance

'Best lap distance' is the total distance covered by the vehicle corresponding to the best ever average speed.

### 4.2d. Best lap timer

'Best lap timer' is the total time taken by the vehicle corresponding to the best ever average speed.

### Note

*All the above values can be reset by pressing the 'SET' button for more than 3 secs in vehicle static condition.*

## 5. BT pairing mode

This mode can be entered by pressing 'MODE' button for 5 secs from any mode.

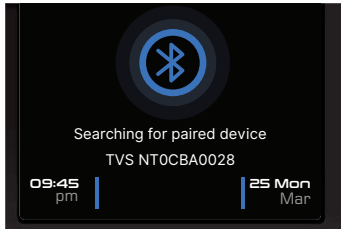

The connected instrument cluster of your TVS NTORQ 125 XT can be connected to your Android™ smart phone and iPhone® via Bluetooth® through a **TVS CONNECT** app which can be downloaded from Google Play store and the App Store®.



**TVS CONNECT**

### Note

*In this mode, if the vehicle speed crosses above 2 km/h, the connected instrument cluster will enter to 'STREET MODE' automatically.*

### First time Bluetooth pairing:

To pair your Android smart phone or iPhone with your TVS NTORQ 125 XT's connected instrument cluster, via Bluetooth, for the first time, follow the procedure as described below :

1. Switch 'ON' the vehicle.
2. Speedometer can be in any mode for first time pairing.
3. Open the app and press the '**CONNECT**' tab, ensure the smart phone is near to the vehicle.

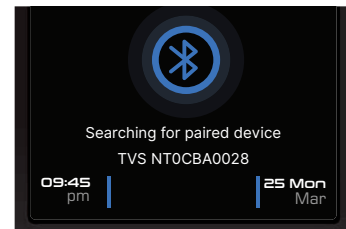



- The app searches for all Bluetooth devices near by and displays the list of devices available.
- The connected instrument cluster's Bluetooth name is prefixed by TVSNT and followed by alpha-numeric digits. Ex : 'TVSNT0CBA0028'. This Bluetooth name can be found by changing the cluster mode into BT pair mode.
- Now, select the 'TVSNT0CBA0028' in app to initiate the pairing process.
- On pairing, the TFT display of connected instrument cluster displays 'NTORQ is now connected' message for 3 secs. A Bluetooth icon '⌘' also will be displayed on the speedometer's TFT display. In Addition to this icons, phone's battery icon and signal strength icon will be displayed on connected instrument cluster TFT display.

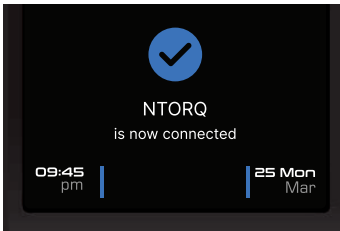

- For initiating first time pairing, logout from the app, login again using your login credentials and then press 'CONNECT'.

### Note

*During the course of pairing process, if there is any occurrence of error, the connected instrument cluster should be turned 'OFF' and 'ON', and the application also need to be restarted.*

*Please remember that all the smart phones are not compatible for pairing with the TVS NTORQ 125 XT's connected instrument cluster.*

*During the search of Bluetooth devices in app, if the vehicle connected instrument cluster's Bluetooth device ID is not visible, try for one or two more iterations.*

## Note

*In this mode, if the vehicle speed crosses above 2 km/h, the connected instrument cluster will enter to 'Street mode' automatically.*

*Any number of Android phones can be auto-paired with the instrument cluster, but only one at any point of time will be in actively connected with the speedometer.*

*Only one iPhone can be auto-paired with a single instrument cluster at a time. If the user need to connect multiple iPhones with the single instrument cluster, the previous connected iPhone has to be forgotten by clicking, 'Forget This Device' from Bluetooth settings in the iPhone.*

*If the vehicle battery is reset or fuse is blown, then 'Forget This Device' from Bluetooth settings.*

## Steps to "Forget This Device" in iPhone:

If the user needs to connect multiple iPhones with the single instrument cluster, the previous iPhone has to be forgotten using "Forget This Device" from Bluetooth settings in the following manner:



1. In the previous connected iPhone, open the SETTINGS -> BLUETOOTH.
2. Select the instrument cluster, which was connected previously.
3. Click on the "Forget this device"



### Auto pairing

Once the first time pairing is done between vehicle's instrument cluster and your smart phone, the phone will automatically connect with the vehicle when the following conditions are met:

1. Vehicle is switched 'ON' and vehicle is near to the smart phone.
2. Smart phone's Bluetooth is turned 'ON'
3. First time pairing is ensured.
4. In case of iPhone, the 'TVS CONNECT' app should be open or be open in background for auto-pairing to happen.

Every time auto-pairing happens, app will open automatically and connect with the Instrument cluster. The connected instrument cluster's TFT display shows 'NTORQ is now connected'.

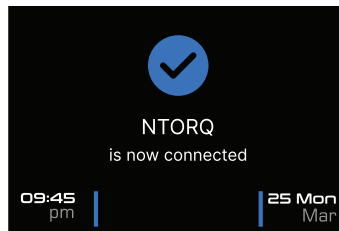

If your smart phone is disconnected from the vehicle's instrument cluster then, 'Bluetooth disconnected Connect again' message will be displayed on the connected instrument cluster's TFT display.

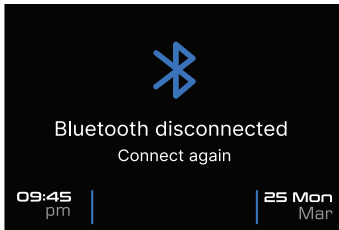

If your smart phone is connection is unsuccessful from the vehicle's instrument cluster then, 'Try again Connection unsuccessful' message will be displayed on the connected instrument cluster's TFT display.

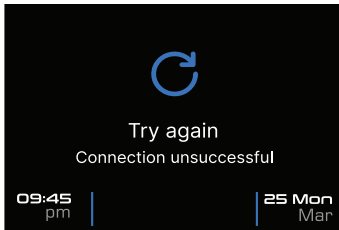

### Note

*If the phone enters battery saver mode, auto-pairing might not happen. It takes maximum of five minutes for auto-pairing and it can happen in vehicle running or engine at idling or engine off condition.*



*Auto-pairing happens only if the application is locked in the RAM in multitasking screen of the phone which has customized OS (Ex : MI, Vivo etc.)*

*In case of Android phones with Android OS version above 8.0, for App to work seamlessly, any battery optimization setting to be removed in the TVS Connect App and GPS shall be allowed to run in background in high accuracy mode.*

*Even if your phone's Bluetooth is already paired to other gadgets like smart watch, health band or helmet, the auto-pairing works with your TVS NTORQ 125 XT 's connected instrument cluster.*

*If the application unfortunately stops due to unforeseen circumstances, close and reopen the application and do the manual pairing for the first time, then auto pairing will happen subsequently.*

*For first time pairing, logout from the app, login again with your login credential and press 'CONNECT' tab.*

Once the connected instrument cluster of your TVS NTORQ 125 XT is connected with your smart phone, the connected instrument cluster displays Bluetooth '  ' icon, your mobile's battery level '  ' icon and network provider's signal strength '  ' icon.

### Note

*In case multiple SIM cards are used in smart phone, by default, SIM 1's network provider's signal strength is shown in the display of connected instrument cluster.*

*Signal strength displayed in the connected instrument cluster might vary from the display in smart phone as the former is referred from telephonic standards.*

### Incoming call alert display ' '

The connected instrument cluster's TFT will display the incoming calls alerts from the smart phone via Bluetooth. Ex. 'Aarav incoming call', will be displayed if the contact is stored in the smart phone's otherwise number will be displayed. Ex. '9999999999 incoming call'.

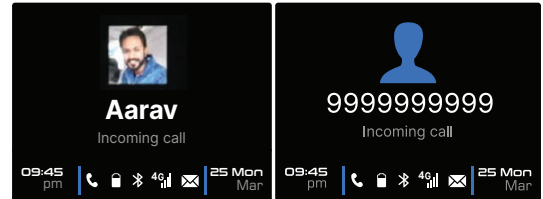

### Social media alert

The connected instrument cluster's TFT displays the total number of notification from social media apps like WhatsApp™, Facebook™, Instagram™ in the smart phone via Bluetooth.

### Missed call alert display '☎'

The connected instrument cluster's TFT displays the total number of missed calls from the smart phone via Bluetooth for 10 seconds approx., Ex. '3 Missed calls' with the names / numbers of the callers.

### SMS alert display '✉'

The connected instrument cluster's TFT displays the incoming SMS from the smart phone via Bluetooth, Ex. 'Aarav Message received', name of the sender will be displayed. If the contact is not stored in the smart phone then the number will be displayed as shown Ex. '9999999999 Message received'.

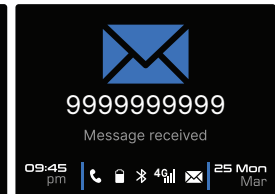
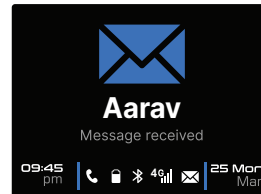

## Traffic stop

When the vehicle is stopped at traffic signal or any stop, the connected instrument cluster's TFT display switch between traffic screens as shown bellow.

1. ISS countdown
2. Overview screen
3. ISS feature screen
4. Cricket score
5. Football score
6. Three news
7. Weather
8. Two news

## ISS countdown

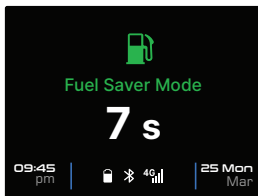

## Over view screen

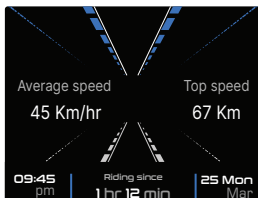

## ISS feature screen

Instruction for start after Fuel saver mode

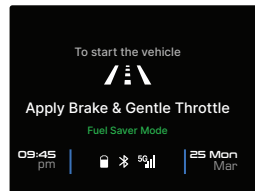

## Cricket, football score

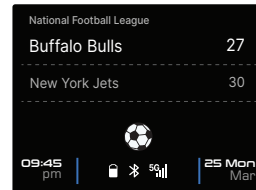
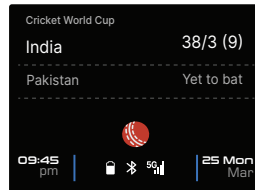

## News

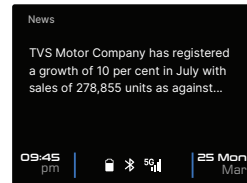
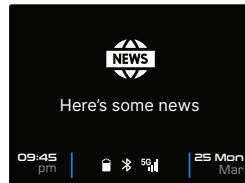

## Weather/ AQI

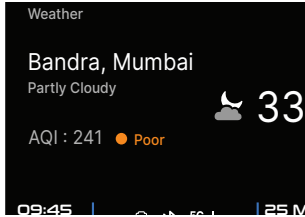

### Note

Each screens will be in displayed for 55 seconds in loop.

Weather / AQI, cricket, football, news will only be available when the cluster is connected to your mobile with Internet connection, standard data charges will apply. If no Internet connection or poor connection the following message is displayed.

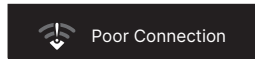
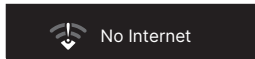

### Note

Any of these features can be disabled and enabled by using TVS Connect app's setting options tab.





## Warning

***TVS Motor Company Limited does not recommend usage of any type of Mobile Hand Held Devices, and applications / features whether installed or associated with the vehicle which deprives the rider's attention and focus while riding the Two Wheeler. The customers and riders are strictly advised to understand the applicable laws, road safety Rules and the local laws on usage of electronic devices while operating the vehicle. Usage of any Mobile or hand held devices, and / or applications / features while riding the vehicle is on move is totally at customer's / rider's risk. The product and features have technical limitations and are for general overview only.***

## 6. Set Date

To enter the set clock mode, press the 'MODE' button for more than 5 secs in BT pairing mode.

- Press the 'MODE' button the year gets highlighted.
- Press the 'SET' button to change the years (the year starts from 2020 to 2040).
- On Pressing the 'MODE' button again, the year gets set and the month gets highlighted.
- Now press the 'SET' button to change the month.
- Once again press the 'Mode' button so that month is 'SET' and date gets highlighted.
- Press the 'SET' button the change the date.
- Long press the 'MODE' button once again to the set the date and to come out of set date mode.



## 7. Set Time

To enter the set clock mode, press 'MODE' button for more than 5 secs in Set date.

- Press the 'MODE' button the hours gets highlighted.
- Press the 'SET' button to increase the hours.
- On Pressing the 'MODE' button again the hours gets set and the minute digits gets highlighted.
- Now, press the 'SET' button to increase the minutes.
- Once again press the 'MODE' button so that the minutes of the clock is set and the hours format 'AM' or 'PM' gets highlighted.
- Press the 'Set' button to change the hour format either to set 'AM' or 'PM'.

Long press the 'MODE' button once again to set the time and to come out of set time mode.



## Note

*In this mode, if the vehicle speed crosses above 2 km/h, connected instrument cluster will enter to 'Street mode' automatically.*

*If no input is given for more than 5 secs while the set clock mode is in operation, the connected instrument cluster comes out of this mode automatically.*

*The date and time gets sync automatically on pairing your smart phone with the connected instrument cluster provided if auto sync clock setting is enabled in app.*

## 8. Setting

You can personalize the display settings which includes Brightness and information.

Setting can be entered by pressing 'MODE' button for 5 sec from Bluetooth pairing mode.

### 8a. Brightness

The brightness of the connected instrument cluster can be adjusted.

- In setting, press the 'SET' button to enter day brightness option.
- Press the 'MODE' button to increase or decrease the day theme brightness.
- Again press the 'SET' button to set the brightness.

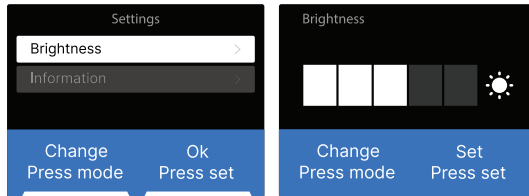

## 8b. Information

The software version of the connected instrument cluster can be viewed.

- In setting, Navigate to information option by pressing the 'MODE' button.
- Press the 'SET' button to enter information option.
- Long press mode to exit.

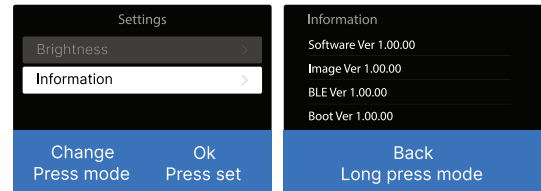

## NOTIFICATIONS

### E-Commerce alert notifications

E-commerce notification will be sent as a notification to the user in TVS NTORQ 125 XT.

#### Note

*E-Commerce alert notification is applicable only for Android smart phones.*

### Service reminder notification

Refer page no. 37 for details.



### Low fuel notification

Refer page no. 36 for details.



### Battery voltage low notification

Refer page no. 36 for details.



### Check fuel sensor notification

Refer page no. 37 for details.

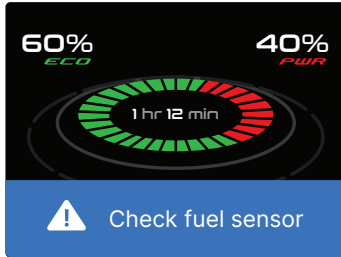

### High speed alert & phone battery low

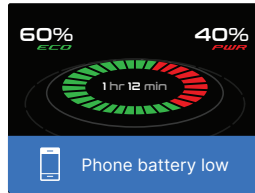
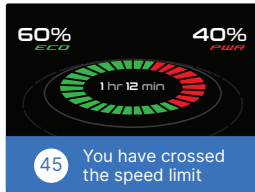

### National celebration images

National days like republic day and independence day will be displayed in the TFT screen.



### Birthday notification

The connected instrument cluster will wish you on your birthday in TFT screen.



## Note

*Date of birth has to be updated in TVS Connect app for the cluster to display the birthday notification*

## Bike anniversary

The connected instrument cluster will wish you on your bike anniversary in TFT screen.



## Achievements notification

Achievements such as top speed, Shortest time etc will be displayed.

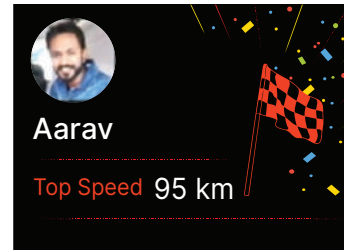

## TVS CONNECT APP



Dedicated smart phone app is available in the Google Play and the Apple store for your 'TVS NTORQ 125 XT' and it can be installed in your Android and Apple smart phones. To access the features of your TVS NTORQ 125 XT's connected instrument cluster like:

- Incoming call alerts in connected instrument cluster.
- Incoming SMS alerts in connected instrument cluster.
- Image transfer feature.
- Number of missed call alerts in connected instrument cluster.
- Voice assist & smart talk.
- Battery status of your smart phone in connected instrument cluster.
- To send auto reply SMS to the callers via smart phone (applicable only for Android smart phones).
- "Do Not Disturb" mode during the ride (applicable only for Android smart phones).
- To send navigational assist instructions inputs to the connected instrument cluster from your smart phone.
- Traffic screens
- To save the last traveled route.
- To locate the last parked location of your TVS NTORQ 125 XT.
- To know the signal strength of your mobile network in connected instrument cluster.
- To generate, store and share Ride reports.
- To sync the connected instrument cluster clock with smart phone clock.
- To control the background illumination of the Instrument cluster.

This dedicated mobile app of your TVS NTORQ 125 XT can be downloaded from the Google Play store and the App Store® by searching the key word '**TVS CONNECT**' else by scanning the below QR code.



Android



iOS



## Note

*This smart phone app is compatible only for the smart phones with Android OS version Kitkat (4.4) and above, iOS version 9 and above and the BLUETOOTH version 4.0 and above. Android and Google Play are trademarks of Google LLC. App Store® and iOS are trademark of Apple.*

## How to login

On opening the **TVS CONNECT** app the following introductory screens will be displayed.



Move to the last screen where you will find the 'SIGN UP' and 'LOGIN' tab. If you are having login already then press login tab. A screen with various login options opens-up as shown.



You can login using your social media logins like FACEBOOK and GOOGLE or using your mobile number which has been registered already.

If you are a new user then press the sign up tab where you will find various options for registering using your social media logins like FACEBOOK and GOOGLE or a tab for creating new account.

Using your social media logins you can create new login else press the 'CREATE AN ACCOUNT' tab. On pressing the 'CREATE AN ACCOUNT' tab, a screen opens with various input details. Feed in your details and submit. On submitting the details a screen opens with one time password (OTP) entry.

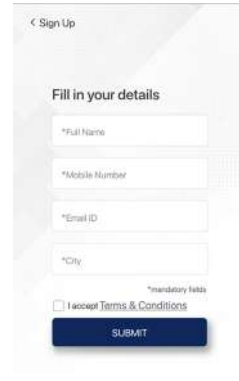

Enter the OTP which is received from TVS Motor Company Limited and submit. On submitting the OTP, another screen opens where you have to enter your vehicle's chassis number for verification.

## Add vehicle

Add vehicle tab allows you to add any of your TVS bikes by entering its chassis number. You can have sample view of the frame number and also you can get help by chatting with us or by E-mailing to us or by calling us.

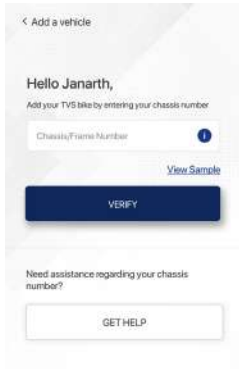

< Add a vehicle

Hello Janarth,  
Add your TVS bike by entering your chassis number

Chassis/Frame Number

View Sample

VERIFY

Need assistance regarding your chassis number?  
GET HELP



TVS

Janarth  
My Profile

Hi Privacy/Share-Info, need help getting started?  
Tap to know more about app optimization  
KNOW MORE >

Select a vehicle to explore more

NTORQ

CONNECT

12 Total Rides 53.2 km Distance 62.0 km/h Top Speed

Vehicle Overview My Rides Services

My Vehicle Search Ride Community

After successful verification of your chassis number, the Home screen of the app opens.

## Note

Please remember that the Navigation License has to be renewed after 5 years of vehicle purchase and renewal can be done by contacting near by Dealer end.

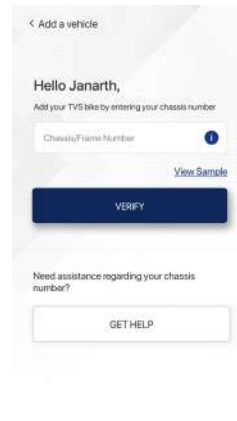

< Add a vehicle

Hello Janarth,  
Add your TVS bike by entering your chassis number

Chassis/Frame Number

View Sample

VERIFY

Need assistance regarding your chassis number?  
GET HELP



< Get Help

Need assistance with updating your phone details? Get in touch

Chassis No\*: XXXXXXXXXXXXXXXXXXXXXXX

Name\*: Gowtham

Upload RC copy or TVS Vehicle invoice\*: Upload  
Maximum size of 15 mb allowed

Upload Govt. issued ID (like DL)\*: Upload  
Maximum size of 15 mb allowed

Number to be updated\*: Mobile

Comments:  
Add your comments

SUBMIT

## Voice assist

We have upgraded our electric start switch with an additional function to invoke voice assistant. Once, the mobile app is connected to the speedometer.

There are two ways to invoke voice assist in your scooter:

1. By pressing the Electric start / Voice assist switch for >2s.
2. By pressing the voice assist icon in the app live dashboard as shown on the image. This will work irrespective of engine is 'ON/OFF'.



## Note

**Voice assist will work with screen lock condition / app background condition.**

**Use wired / wireless headphone for listening and talking. Voice feedback will work only if a wired / wireless headphone is connected.**

**Option to enable / disable voice assistant and voice feedback is available in App settings.**

After invoking voice assist through either of the two ways, "Hello, How can i help you?" will appear on the screen and a speak now will be heard on the headset. This is when we have to start speaking / providing the command.

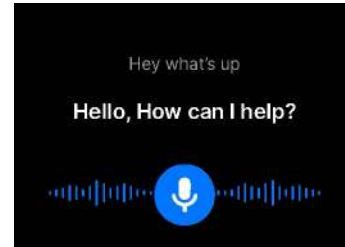

The following are the list of intents recognized by voice assist. You can refer page no. 67 for sample commands of each intent:

- Greeting command
- Navigation command
- Nearest POI command
- Mode change command – Sport / Street modes
- Brightness increase / decrease command
- Current location / save location command
- Weather update command
- Music player command
- Volume increase / decrease
- Enable / Disable Auto SMS
- Enable / Disable Do Not Disturb
- Enable / Disable High Speed Alert
- News / sport news update command

## Voice assist commands and key words

S. No.	Intent	Voice Feedback	Acceptable command variations
1	GREETING	Hello 'rider name'	Hello buddy
			Hello friend
			Hello ntorq
			How are you doing
2	MODE STREET	Street Mode activated	Street Mode
			Activate street mode
			Go to street Mode
3	MODE SPORT	Sports Mode activated / already your in sport mode	Sport mode
			Activate Sport mode
			Change to sport mode
			Go to sport Mode
			It's race time
			Let's heat up the engine
			Let's move on to race mode

S. No.	Intent	Voice Feedback	Acceptable command variations
4	NAVIGATION	Taking you to ' ____ '	Directions to
			Go to
			Guide me to
			Let's go to
			Navigate me to
			Navigate to
			Show me
			Show me directions to
			Take me to
5	NAVIGATION	Taking you to ' ____ '	Take to
6	POI	Taking you to nearest ' ____ '	Near by
			Near to
			Nearest
7	POI HOSPITAL	Taking you to nearest hospital	Near hospital
			Nearby hospital
			Nearest hospital
			Take me to nearest hospital



S. No.	Intent	Voice Feedback	Acceptable command variations
8	POI PETROL PUMP	Taking you to nearest petrol pump	Petrol pump
			Gas station
			Near petrol pump
			Near petrol station
			Nearby petrol pump
			Nearby petrol station
			Take me to nearest fuel station
			Take me to nearest petrol pump
			Take me to nearest petrol station
9	POI RESTAURANTS	Taking you to nearest restaurant	Near restaurant
			Near to restaurant
			Nearby restaurant
			Nearest restaurant
			Take me to nearest restaurant
10	POI SERVICE CENTER	Taking you to nearest TVS service center	Near by service center
			Near service center
			Near to service center
			Near to TVS service center
			Near to TVS show room
			Take me to nearest service center



S. No.	Intent	Voice Feedback	Acceptable command variations
11	BRIGHTNESS INCREASE	Brightness increased / Maximum brightness	Brightness high
			Brightness Increase
			Brightness up
			Increase brightness
			Increase speedo brightness
			Increase the brightness
			Turn up the brightness
12	BRIGHTNESS DECREASE	Brightness decreased / Minimum brightness	Brightness low
			Brightness decreased
			Brightness UP
			Decrease brightness
			Decrease speedo brightness
			Turn down the brightness
13	CURRENT LOCATION	You are around ' ____ '	My location
			Show my current location
			Show my location
			What is my current location
			Where am i now
			What is my location

S. No.	Intent	Voice Feedback	Acceptable command variations
14	SETTING AUTO SMS DISABLE (only in Andriod smartphones only)	Auto SMS reply disabled	Auto reply SMS OFF
			Auto SMS OFF
			Disable auto SMS
15	SETTING AUTO SMS ENABLE (only in Andriod smartphones only)	Auto SMS reply enabled	Auto reply SMS ON
			Auto SMS ON
			Enable auto SMS
16	SETTING DND DISABLE (only in Andriod smart-phones only)	Do not disturb setting disabled	Disable calls while riding
			Disable DND
			Disable do not disturb
			DND mode disable
			Do Not disturb OFF
			Do not disturb setting disable
			Do not disturb setting disable
17	SETTING DND ENABLE (only in Andriod smart-phones only)	Do not disturb setting enabled	DND mode enabled
			Do Not disturb ON
			Do Not disturb enable
			Enable DND
			Enable do not disturb

S. No.	Intent	Voice Feedback	Acceptable command variations
18	SETTING HIGH SPEED ALERT DISABLE	High speed alert setting disabled	Disable high speed alert
			Disable high speed alert
19	SETTING HIGH SPEED ALERT ENABLE	High speed alert setting enabled	Activate high speed alert
			Activate high-speed alert
			Enable high speed alert
			Enable high-speed alert
20	VOLUME DECREASE	Volume Decreased	Decrease sound
			Decrease volume
			Reduce volume
			Volume down
21	VOLUME INCREASE	Volume Increased	Increase sound
			Increase volume
			Volume up
22	NEXT SONG (only in Andriod smart-phones only)	NA	Next song
23	PREVIOUS SONG (only in Andriod smart-phones only)	NA	Previous song

S. No.	Intent	Voice Feedback	Acceptable command variations
24	PAUSE SONG (only in Andriod smart-phones only)	NA	Pause song
			Stop song
25	PLAY SONG	NA	Continue song
			Resume song
			Play song
26	RAIN TODAY	Take RainCoat (probability > 75%)	Rain today
			What about rain
			Here rain status
			Rain update
			Will it Rain today
27	WEATHER UPDATE	Weather update	Current weather
			Weather today
			Weather update
			What is the weather
			What is the weather today
			What is the weather update

S. No.	Intent	Voice Feedback	Acceptable command variations
28	AQI UPDATE	Air quality index is You are around ' ____ '	Air quality
			Air quality index
			Air quality today
			Today AQI
			AQI today
			Air quality intex
			What is the air quality today
29	NEWS HEADLINES	NA	Current news
			News headlines
			Headlines today
			Top news
			Todays news
			News update
30	SPORTS NEWS	NA	Sports news
			Sports update
31	CRICKET SCORE	NA	Cricket match
			Cricket news
			Cricket score
			Cricket updates

S. No.	Intent	Voice Feedback	Acceptable command variations
32	FOOTBALL SCORE	NA	Football match
			Football news
			Football score
			Football updates
33	PAUSE NAVIGATION	Navigation Paused	Stop navigation
			Pause navigation
34	RESUME NAVIGATION	Navigation Resumed	Play navigation
			Start navigation
			Resume navigation

## Note

*The list of commands and intent will be updated periodically. Please refer to the command list mentioned in the mobile app to stay updated.*

### **Things to do while using voice assistant:**

1. We recommend to use ANC (Active Noise Canceling) Bluetooth devices for better performance.
2. Ensure Microphone is kept near to your mouth while giving out commands.
3. Please ensure that it is not exposed to outside environmental noise such as wind noise, other vehicles' noise etc.
4. We recommend you to go through the sample command list before trying your intent.
5. Kindly refer to the voice feedback of the detected place name when you provide voice command for navigation.
6. Make sure you have the engine running when voice assist is invoked through vehicle switch.

### **Things not to do while using voice assistant:**

1. We recommend you not to use the method of invoking voice assist through mobile App while riding.
2. Please do not use voice assist functionality during heavy traffic condition.

### Smart talk

TVS NTORQ 125 XT is equipped with yet another first-in-class feature – Smart talk.

Smart talk feature communicates from vehicle to customer of either critical parameters like fuel level or achievements done like top speed achieved as shown below:

Sl. No.	Smart talk feature
1	Info through audio feedback when App connect / disconnects
2	Fuel wastage
3	Fuel warning
4	Phone low battery warning
5	Voice over on automatic Traffic sequence
6	Rain warning



## Terms & Conditions

- SmartXonnect feature is now enhanced with Voice Assistance capability. This will enable the user to control certain characteristics of the vehicle in a safe manner.
- Customers can use the voice commands listed as part of the voice assistance feature to improve their riding experience.
- SmartXonnect Voice Assistance is intended to minimize the use of Mobile phones while riding, in turn providing an exciting experience with the Bluetooth enabled system. We recommend users to take caution when providing voice commands.
- SmartXonnect Voice Assistance can be experienced with the help of following entities - TVS Connect App, TVS NTORQ 125 XT and a suitable Bluetooth accessory having a microphone and speaker. Users are recommended to wear certified helmets always while riding.
- In cases where customer uses a Bluetooth neckband or headset, it is recommended to always wear helmet.
- The Bluetooth® word mark and logos are registered trademarks owned by Bluetooth SIG, Inc., and any use of such marks by TVS Motor Company Limited., is under license.
- Customers must always be cautious of the surroundings when using the SmartXonnect Voice Assist feature, especially while crossing intersections, in traffic, etc. Customers must always observe the roadway, signs, and signals carefully. Lack of attention can cause serious injury or loss of life. TVSM is not liable for any such mishaps.
- Customers must always obey traffic laws while riding. TVSM is not liable for any penalty caused due to user's lack of caution in obeying traffic laws
- Costs of network communication and communication equipment necessary for the use of SmartXonnect voice assist feature shall be borne by the user himself/herself.
- Some smartphones may not be compatible with the SmartXonnect Voice Assistance feature. We shall not be liable if there is delayed response from the voice assistance feature due to poor internet connection or the phone's performance limitations.

- Use of mobile phones while riding is not safe and is prohibited as per Motor Vehicle law and rules as framed by central / state governments. Hence, Customers should not use the mobile phone while riding. We shall not be liable for any penalties, damages for any violation or trouble in the use of smartphone while riding.
- Bluetooth hands free devices are not included as part of the package
- SmartXonnect Voice assist feature also provides display information in the cluster. Users are advised to verify the voice guidance and information in the meter provided by the system carefully. If you are unsure, proceed with caution. Always use your own good judgement, and obey traffic laws while riding
- Changes in operating systems, hardware, software, and other technology integral to providing SmartXonnect Voice assistance feature, as well as new or revised governmental regulations, may result in a decrease or cessation of SmartXonnect Voice assist functionality and services. TVSM cannot and does not provide any warranty or guarantee of future SmartXonnect Voice assist performance or functionality.

### **LED HEAD LAMP CUM POSITION LAMP WITH ALL TIME HEAD LAMP ON (AHO)**

TVS NTORQ 125 XT comes with a LED head lamp cum position lamp. Position LED which glows automatically once the ignition is turned 'ON' and LED head lamp glows automatically when the engine is started, only the head lamp beam (high/low) can be controlled by pressing the high/low beam switch.



## FUEL TANK\* CAP

Fuel tank is located at the rear end of the vehicle below the pillion holder.

To open the fuel tank cap, insert the control key into the 'seat cum fuel tank cap lock' and turn it in anti-clockwise direction. The fuel tank cap opens automatically. To close the cap, gently press the cap back to its position and ensure locking of the cap by hearing '**click**' sound.



\* The fuel tank is not a measuring instrument and the capacity of the fuel tank may slightly vary from the indicated capacity.

### Warning

*Never refill fuel near open flame. Do not smoke while refueling. Do not use cell phones while refueling.*

### Caution

*Ensure that the fuel gun is inserted fully in the tank neck while refueling.*

*Whenever refueling, fill upto the bottom of neck portion (insert level) of the fuel tank. Filling above the neck may result in improper breathing of fuel tank and seepage of fuel.*

*While refueling, avoid spillage of petrol on the tyre. If fuel spills on tyre, the tyre will loose its grip on the road. Ensure to close fuel tank cap without fail to avoid fuel spillage.*

## EFFORTLESS E-Z CENTRE STAND

TVS NTORQ 125 XT is equipped with a effortless centre stand. The centre stand (1) has a pivoted flexible spring loaded lever arm (stand extension) (2) to increase the lever ratio, which enables parking on centre stand effortlessly and very conveniently.



To place the vehicle on centre stand, hold the handle bar left grip with left hand, place your foot firmly on the centre stand extension (2) while ensuring that both the stand shoes are touching the ground, press the stand extension.

### Warning

***Always retract the side stand to its full up position before moving the vehicle. Else, the vehicle will get 'OFF'.***

### Caution

***Never sit on vehicle when it is supported by stands. Always park the vehicle on a flat, firm surface.***

## SIDE STAND



Side stand can be operated by sitting on vehicle with your left foot by pushing it away from the vehicle till it stops.

### **Warning**

*Always release the side stand to its full up position before starting the vehicle. Else the vehicle will not get start.*

## KICK STARTER SYSTEM#

Kick starter system is an optional accessory and can be fitted on your vehicle on chargeable basis if you prefer. Contact TVS Motor Company Authorised Main Dealer / Authorised Dealer for the fitment.

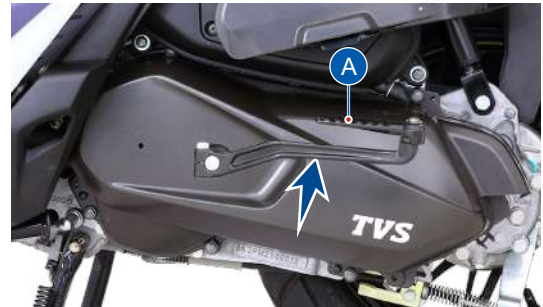

### **Caution**

*Put the vehicle on center stand before applying the kick starter lever to avoid kick lever hitting with center stand.*

*# Optional accessory will be charged extra*

To start the vehicle using kick starter (if fitted on your vehicle), park the vehicle on centre stand and keep the ignition in 'ON' condition.

Move the lever extension (A) outwards and keep your foot on the lever extension. **Kick the lever from top and stroke to bottom with rapid motion.** Push back the lever extension to its original position once the vehicle is started.

### TOOL KIT AND FIRST AID KIT

To assist you in performing certain aspects of periodic maintenance and emergency repairs, a tool kit is supplied along with the vehicle and it is located below the seat base.



To access the tool kit, insert the control key into seat lock and rotate it in clockwise direction. Lift and open the seat.

The tool kit consists one number each of the following. Ensure the contents of the tool kit.

1. 10x12 mm spanner
2. Combination screw driver bit
3. Screw driver handle
4. Tool bag

### Caution

*It is recommended to use the tool kit in case of any emergency only. It is always advisable to take your vehicle to TVS Motor Company Authorised Main Dealer / Authorised Dealer.*

## UTILITY BOX

Utility box is located below the seat. Lift the seat by unlocking the seat lock as explained in the previous page, to access the utility box.



## Warning

*Operating the TVS NTOUQ 125 XT overloaded will hamper riding stability and may lead to loss of control. Hence, it is advisable to carry the recommended amount of load only.*

## Caution

*Utility box can be used to carry a load of 10 kg maximum.*

*Do not carry perishable items inside the utility box. It is not fully sealed. Do not allow / spray water to get inside the utility box. Take care not to spill petrol or oil into the utility box.*

*Do not keep heat-sensitive items inside as it may get hot on long rides.*

*Do not keep valuable items inside the utility box when leaving the vehicle unattended.*



## HELMET HOOKS

Two helmet hooks are provided under the seat assembly at front end near the seat hinge to secure your helmet. Open the seat assembly (refer page no. 84) to access the helmet hooks. Hook the helmet strap in the helmet hook properly and close the seat assembly.



## BAG HOOKS

There are two bag hooks provided with your scooter to carry light luggage like carry bags weighing upto 3 kg. One hook is located below handle bar on the rear panel.

Just pull out the hook from the top (A) to hang your luggage. Push back the hook once it is free.

Similarly, the other one is located on the cover front below front end of the seat assembly. Pull out the hook from its position. Open the top lid and hang your cargos. Lid will get close automatically. Push back the hook to its original position once it is free.



## Caution

*Care should be taken not to attach the luggage which hangs out of your scooter. Please note that the luggage attached to your scooter should not interfere your feet movement.*

## SMART PHONE CHARGER

All new smart phone charger has been provided in the utility box of your vehicle (refer page no. 85). Please follow the guidelines mentioned below for using it properly:

### DO's

1. Ensure that no water enters into the unit, by closing the USB flap properly.
2. Use the USB only if approved standard USB cable used for charging your mobile.
3. Do make sure the flap (A) is not damaged while opening / inserting the USB cable.

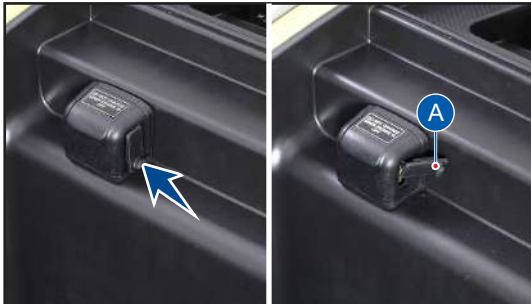

### DON'Ts

1. Do not leave the USB charging flap open / partially closed.
2. Do not attempt to use / charge any other device, other than mobile phones. Only one mobile phone should be charged at a given time.
3. Do not try to force the USB connector in, check whether it is inserted in the appropriate direction, to prevent the damage to the charger.
4. Do not charge your mobile when engine is off.



### Caution

*The charging time of the mobile may vary, depending on the mobile's battery state of charge. The rubber flap in the unit has been designed to prevent water entry and is not replaceable. No warranty for charger in case of rubber flap cut.*

## PRE RIDE INSPECTION

Check the following items before riding

ITEM	WHAT TO CHECK FOR
Engine oil	Availability of oil upto the level (page no. 102)
Transmission oil	Availability of oil upto the level (page no. 103)
Fuel	Enough fuel for the planned distance of running
Tyres	Correct pressure (page no. 107) Adequate tread depth / No cracks or cuts.
Battery	Proper working of electric starter, horn, fuel gauge, pass by, brake lamp and turn signal lamps. Battery voltage (page no. 97)
Lighting	Proper working of head lamp high / low beam, DRL, high beam indicator, position lamp, connected instrument cluster back illumination, tail lamp and number plate lamp.
Steering	Smooth movement / no play or looseness
Throttle	Correct free play of cable / smooth operation
Brakes	Correct front / rear brake lever play (page no. 104) Availability of brake fluid and proper working of brake (page no. 104)
Wheels	Free rotation of front and rear wheels

## STARTING THE ENGINE

Ensure availability of adequate fuel in the fuel tank. Insert the control key into the ignition cum steering lock and turn it to the 'ON' position. In side stand retracted condition, apply any one of the brake and press the electric starter switch to start electrically.

### Setting the vehicle in motion

1. Twist the throttle grip slowly towards you and simultaneously release the brake lever gently and smoothly. The vehicle will start moving forward.
2. As the vehicle picks up speed, increase the throttle slowly.



### Caution

*Do not keep the engine in idling rpm for long and do not open excessive throttle when the vehicle is on side stand or off stand with brakes applied condition. It leads to overheating of engine and damage to the internal components.*



### Warning

*Do not raise the throttle rapidly so the vehicle will move forward suddenly and lead to loss of control.*

## Stopping and parking

1. Close the throttle completely and apply both the brakes simultaneously.
2. Turn the ignition 'OFF'.
3. Park the vehicle on a firm, flat surface.
4. Lock the steering and take out the control key.



### Warning

*Reduce speed to a safe limit before turning / cornering. Do not apply brake while turning / cornering.*

## FUEL RECOMMENDATION

Use only BS VI petrol with minimum RON 91. BS VI petrol containing upto 10% of ethanol by volume can be used.

Higher ethanol content in petrol can

- degrade plastic and rubber components of fuel system and vehicle parts
- cause corrosion damage to metal parts like fuel tank, etc
- result in startability & drivability issues
- decrease fuel economy

Ethanol absorbs water very easily, resulting fuel separation. Extra care shall be taken to prevent moisture entry into fuel tank while filling ethanol blended petrol and water washing of vehicle.

Painted parts (viz. panels, covers) shall not come in contact with ethanol blended fuels.

Manufacturer is not responsible for any warranty issues that results from using ethanol blend in excess of 10% by volume.

In case of any abnormalities observed due to use of ethanol blended fuels, customers are advised to use a different fuel station/brand for standard E10 fuel or contact authorised service centres.



### Caution

*Never mix oil in petrol in the fuel tank. Always fill fuel from the reputed and reliable fuel stations.*

## CHECKS AND TIPS FOR IMPROVING FUEL ECONOMY

### Regular checks

Carry out the periodic maintenance checks as specified in this manual (page no. 92).

Regular maintenance checks will save fuel and ensure trouble-free, enjoyable and safe riding besides keeping environment clean.

### Spark plug

A dirty or defective spark plug leads to wastage of fuel due to incomplete combustion. Clean and adjust the spark plug only if necessary. **Replace the spark plug every 12000 kms (1 year). Always use recommended spark plug only.**

### Air cleaner element

A dirty air cleaner element restricts airflow and increases fuel consumption. **Replace the element every 12000 kms.**

Since foam and paper type air filter element is used in your scooter, it is recommended to clean the foam filter element using mild compressed air from inside **every 3000 kms.** Replace the filters incase found any abnormalities.

### Engine oil and Transmission oil

Dirty or less engine oil increases the friction between various parts of the engine and reduces the engine life, thereby increases the fuel consumption.

Running with low transmission oil will cause damage to the gears and bearings.

**Regularly inspect the engine oil and the transmission oil for correct level and top-up if necessary. Get it replaced at regular intervals as per the maintenance schedule.**

### Fuel leak

Inspect and arrest fuel leaks if any from tank and fuel lines. Loss of fuel due to leak may drain the fuel tank completely.

### Evaporation

Vehicle parked in the hot sun leads to wastage of fuel through evaporation. Also, lower fuel levels in the tank will have increased evaporation and condensation of moisture inside.

Ensure to close fuel tank cap after every filling. If the fuel tank cap kept open for long time, it leads to safety and fuel loss.

### Tyres

Low tyre pressure has adverse effect on the vehicle. The **drag on the vehicle** increases resulting decreased fuel economy. Further more, handling may be adversely affected.

Inspect the tyre pressure regularly (weekly) and inflate it to the recommended pressure (refer page No. 107). Never use tyres which are worn beyond the permissible limit.

### Wheel freeness

Inspect and ensure the wheel freeness by rotating the wheel at least once in a week to avoid wastage of fuel.

### Avoid unnecessary idling

While waiting for someone or stopping in signals for long time, if the engine is kept running at idle speed, it causes unnecessary wastage of fuel.

### Avoid frequent braking

Anticipate corners and slopes as well as the traffic conditions. **Unnecessary and frequent braking will reduce the fuel economy. Never accelerate and apply brake simultaneously.** It leads clutch shoes wear and wastage of fuel.

### Note

*The on-road mileage of TVS NTORQ 125 XT is dependent on several factors like road condition, quality of fuel, riding speed, operation of clutch and brake, tyre inflation, maintenance / timely servicing of vehicle, load etc. and hence will differ from the mileage given under standard test conditions such as made in recognised institutes.*

## MAINTENANCE SCHEDULE

The maintenance schedule indicates the intervals between periodic services. At the end of each interval, be sure to inspect, check, replace, adjust, lubricate and service as instructed. If the maintenance is not done periodically, it will result in rapid wear and severe damage to the vehicle. If the vehicle is used under high stress conditions such as continuous full throttle operation or is used / operated in dusty area, certain jobs should be performed more often to ensure reliability of the vehicle. Cylinder head, steering components, suspension and wheel components etc., are key items and require very special and careful servicing. TVS Motor Company Limited strongly recommends that the jobs as per the maintenance schedule be performed by your TVS Motor Company Authorised Main Dealer / Authorised Dealer.

Periodic inspections may reveal one or more parts that may need replacement. Whenever replacing parts on TVS NTORQ 125 XT, it is recommended that you use only the TVS Motor Company Genuine parts.



### Caution

*Proper running-in and maintenance are mandatory for making certain that your vehicle is reliable and gives optimum performance at all times. Make sure that the periodic maintenance is performed thoroughly in accordance with the instructions given in this owner's manual.*

*In more dusty areas, the air filter elements required early inspection than the mentioned kilometers to avoid costly damages to the engine. If the elements are found with excessive dirt / clogged with dust, clean foam and paper elements using mild compressed air from inside. Replace the filters incase found any abnormalities.*



## PERIODIC MAINTENANCE SCHEDULE (months or km whichever occurs earlier)

Item	Service km	In free service				After free service		Remarks
		1st 500 - 750 2 months	2nd 2500 - 3000 4 months	3rd 5000 - 6000 8 months	4th 8500 - 9000 12 months	Every 3000 km 4 months	Every 6000 km 8 months	
Engine oil		R	I & T	R	I & T	I & T	R	
Oil filter (strainer)		C	-	C	-	-	C	
Transmission oil		R	I & T	R	I & T	I & T	R	
Spark plug		C & A	-	-	-	-	-	Inspect, Clean and adjust if required, Replace every 12000 km
Air cleaner (foam element)		I & C	I & C	I & C	I & C	I & C	-	Replace every 12000 km (as a set)
Air cleaner (paper element)		I	I	I	I	I	-	Replace every 12000 km (as a set)
Air cleaner oil collection tubes		-	I & DR	I & DR	I & DR	I & DR	-	Drain oil if necessary
CVT filter element <sup>1</sup>		-	-	I & C	-	-	I & C	Replace every 12000 km
Tappet clearance		I & A	-	I & A	-	-	I & A	Inspect for any noise / starting trouble and adjust if required
Drive belt and CVT rollers		-	-	-	-	-	-	Replace every 24000 km
Cover variator <sup>2</sup>		-	-	I, C & L	-	-	I, C & L	
Clutch shoe		-	-	-	-	-	-	Replace every 24000 km
Hose fuel		-	-	-	-	-	-	Inspect every service after four years, replace if required.
Front and rear suspension		I	I	I	I	I	-	Inspect for proper functioning

<sup>1</sup> Inspect for damage

<sup>2</sup> Clean the cover with air.

Contd...



Item	Service km	In free service				After free service		Remarks
		500 - 750 2 months	2500 - 3000 4 months	5000 - 6000 8 months	8500 - 9000 12 months	Every 3000 km 4 months	Every 6000 km 8 months	
All control cables <sup>3</sup>		I, A & L	I, A & L	I, A & L	I, A & L	I, A & L	-	
Throttle grip		-	-	L	-	-	L	Lubricate using grease
Steering smooth operation / play		I & A	-	-	-	-	-	C, L & A with fresh grease every 12000 km
Front fork oil		-	-	-	-	-	-	Replace every 24000 km
All fasteners		I & TI	I & TI	I & TI	I & TI	I & TI	-	
All bulbs, horn and switches		I	I	I	I	I	-	Inspect for proper functioning
Head lamp beam		I & A	I & A	I & A	I & A	I & A	-	
Battery voltage <sup>4</sup>		I	I	I	I	I	-	
Brake effectiveness / play		I & A	I & A	I & A	I & A	I & A	-	Refer page No. 58 & 61 for details
Rear brake cam		-	-	C & L	-	-	C & L	Lubricate using grease
Brake pad wear		I	I	I	I	I	-	Replace if necessary
Brake fluid		I & T	I & T	I & T	I & T	I & T	-	Replace every 21000 km
Brake hose		I	I	I	I	I	-	Replace every three years
Master cylinder cups		-	-	-	-	-	-	Replace every 21000 km
Disc brake SBS cable play <sup>5</sup>		I	I	I	I	I	-	Inspect for brake levers rattling

<sup>3</sup> Inspect for proper operation and adjust play. Lubricate ends using grease

<sup>4</sup> Recharge if necessary with MF battery charger

<sup>5</sup> Adjust if rattling play is observed in both the brake levers

Cont ...

Item	Service km Period from the date of sale	In free service				After free service		Remarks
		1st 500 - 750 2 months	2nd 2500 - 3000 4 months	3rd 5000 - 6000 8 months	4th 8500 - 9000 12 months	Every 3000 km 4 months	Every 6000 km 8 months	
Wheel freeness		I	I	I	I	I	-	
Front wheel bearing		-	-	-	-	-	-	Lubricate using grease every 12000 km
Tyre pressure at cold condition		I & S	I & S	I & S	I & S	I & S	-	
Malfunction codes		I	I	I	I	I	-	Check and resolve the errors using diagnostic tool if the lamp is ON even after starting the engine
Evaporative emission control system		I	I	I	I	I	-	Check for intactness of hoses and canister
Fuel tank assembly**		I & C	I & C	I & C	I & C	I & C	-	
Centre / side stand pivot		L	L	L	L	L	-	Lubricate using TRU4 oil

R - Replace; I - Inspect; T - Top up; C - Clean; A - Adjust; DR - Drain; L - Lubricate; TI - Tighten; S - Set

\*\* Check for abnormal vehicle jerk / noise while opening the cap / leak. If found any, contact TVS Motor Company Authorised Main Dealer or Authorised Dealer.

## RECOMMENDED LUBRICANTS

APPLICATION	QTY	MANUFACTURER	BRAND
Engine oil	880 ml (during regular service) 930 ml (incase of disassembly)	TVS Motor Company	TVS TRU4 SKUUTA oil (SAE 10W30 API-SL, JASO MB)
Transmission oil	120 ml (during regular service) 130 ml (incase of disassembly)	-do-	-do-
Front fork oil	91 ± 1 cc / leg	IOC / HPCL	Gabriel front fork fluid
Disc brake fluid	-	TVS Girling	DOT 3 / DOT 4
Grease	-	Bharat petroleum IOC Bechem Kluber Lubrication	MP Grease no. 3 Servo Gem no. 3 Bechem premium 3 Kluber Centoplex 2

## SELF - MAINTENANCE PROCEDURES

### MAINTENANCE FREE (MF) Battery

Battery is located at the front side of vehicle inside the front panel. The front panel must be removed to access the battery in the following manner:

1. Remove the front panel mounting screws.
2. Gently pull out the front panel by dislocating its lugs.
3. Reassemble the parts in the reverse order of dismantling.

Since the maintenance free battery is fitted on your vehicle it is not necessary to top-up with the distilled water.



But to ensure the battery performance and long life, follow the steps given below:

1. Check the battery voltage as per the schedule. If the voltage is less than 12.4 volts, charge the battery using **recommended MF battery charger** at TVS Motor Company Authorised Main Dealer / Authorised Dealer.
2. Do not add any additional electrical accessories other than recommended by TVS Motor Company Limited.
3. It is recommended to remove the negative (-) terminal first and then the positive terminal (+). Similarly, while connecting connect the negative terminal (-) first and then the positive terminal (+).



4. While connecting the terminals observe the correct polarity. Connect the red wire to the positive (+) terminal and the black wire to the negative terminal (-) of the battery.
5. Petroleum jelly must be applied at terminals to prevent it from corrosion.

Incase of any abnormality or for removal of battery from the vehicle, contact TVS Motor Company Authorised Main Dealer / Authorised Dealer.

### **Caution**

*Never check the battery charge by shorting the terminals. Always connect the positive terminal first (red wire) and then negative (black wire) to avoid sparking.*

*The inversion of the battery wires can damage the battery and the recharging system. Always connect the positive then negative to avoid sparking.*

\* To be done by skilled personnel

### **Recommendations to maintain battery health during prolonged parking conditions**

While your vehicle is parked for prolonged duration, battery continues to discharge and if left unattended can get completely discharged. It is recommended to ride the vehicle for minimum 60 km every week to keep the battery in healthy condition This could be at a stretch in one ride or several rides during the week.

The vehicle speed will vary during the ride but an average speed of minimum 30 kmph will be helpful to ensure proper battery charging. Use kick-starting, if available, to conserve battery charge during such period. This is only a recommendation to maintain battery charge and regular service schedules must be followed to maintain your vehicle in good running condition.

The following is recommendations to users regarding battery maintenance before, during and after long storage of battery:

#### **1. Before Storage**

- a. Store the battery only after fully charging it
- b. Battery fuse to be disconnected and stored safely. This will reduce the sleep mode current and hence enhance storage life of battery.\*

- c. Alternatively, battery connecting wires (positive and negative wires) can be disconnected and fasteners can be secured with battery terminals.\*

## 2. During Storage

- a. Store it at room temperature or lower.
- b. Store the vehicle in the shade and protected from rain and cover the vehicle to prevent rodents from entering and damaging the wires.

## 3. After Storage

- a. Connect the wires and fuse, if disconnected earlier, with ignition switch in OFF position\*

(Above recommendations do not consider storage effects on other systems such as induction and fuel systems and wheels)

### Periodic Maintenance of Batteries:

- Keep top of battery clean
- Check cables, clamps, and case for obvious damage or loose connections
- Clean terminals and connectors as necessary
- Recharge battery if voltage is below 12.4 Volts.

\* To be done by skilled personnel

- Valve Regulate Lead Acid (VRLA) / Lead Acid batteries are prone to water damage. Any water entry, through vents or otherwise; will result in irreparable damage to the battery or the vehicle.

### **Warning**

*Battery develop explosive gases. Keep it away from heat sources. If charging is required the battery must be charged in well ventilated area.*

*Unusable battery must be disposed in environment friendly manner. Do not discard it with household trash. Handover the battery to the battery dealers or to a recycle center that accept used battery.*

### **Caution**

*Never operate the vehicle with discharged battery as it may damage electrical components.*

## FUSE

Non-working of electrical systems may be due to safety fuse failure. Short circuit or overload in the electrical system are the main causes for fuse failure. There are two fuse cases containing three blade type fuses (15A x 1 and 10A x 2) located near the battery. Follow the procedure given below for inspecting and replacing the fuse.

1. Turn 'OFF' the ignition.
2. Remove the front panel as explained earlier.
3. Take out the fuse case from the battery holder.
4. Open the fuse case and pull out the fuse.



Good Fuse

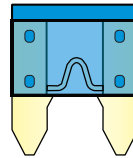

Blown Fuse

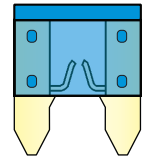

5. Inspect the fuse for failure. If found defective Replace the blown fuse with a new (extra fuses are provided in the wiring harness itself in a pouch).
6. Close and refit the fuse case back to its position.
7. Turn 'ON' the ignition lock and check for proper functioning of the electrical systems. In case the fuse fails again, consult the nearest TVS Motor Company Authorised Main Dealer / Authorised Dealer.

### Caution

*Do not use vehicle by shorting the wires without fuse. This may result in overheating of electrical items / wiring and may result in fire of vehicle.*

*Do not use fuse of higher amperage than specified for the safety of electrical system.*

## SPARK PLUG

To access the spark plug, the cover front has to be removed. Follow the bellow procedure to remove the cover front.

1. Remove the bottom mounting screws (A) of cover front.
2. Open the seat and remove the top mounting screws (B) from both the sides of cover front.
3. Gently pull out the cover front by dislocating its lugs.
4. Clean the dust and mud around the spark plug mounting to avoid falling inside the cylinder.



5. Pull out the suppressor cap from spark plug.  
Using the spark plug spanner, remove the spark plug.

A spark plug with heavy carbon deposits will not produce strong sparks. Hence, only if necessary, clean the carbon deposits from the spark plug with a small wire brush or spark plug cleaning tool.

Inspect the spark plug electrodes (A) and (B) for any corrosion. If found any replace the spark plug with new. Visually inspect the spark plug gap. The gap should be **0.9 ~ 1.0 mm** for **UR5KCW** and **1.0 ~ 1.1 mm** for **RG8MC4**. If the gap is found to be more than the limit replace the spark plug with a new one.

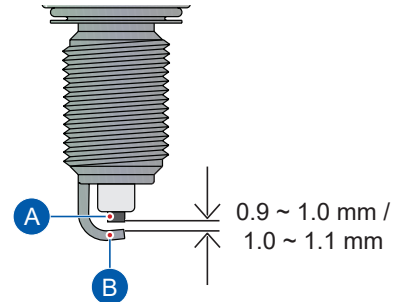



After cleaning and inspecting the gap, reinstall the spark plug and tighten by hand to avoid cross threading. Finally tighten using spark plug spanner. Do not over tight or cross thread the spark plug.

 **Caution**

*Always use only recommended make and type of spark plug. Replace spark plug every 12000 km.*

*Don't remove the spark plug when the engine is hot. Cover the spark plug hole with a cloth when the plug is removed to prevent entry of dust / water.*

*Do not try to adjust the spark plug as it may damage the plug. Replace the plug if the gap is found more.*

*It is advisable to tighten the new spark plug by hand till the end, using plug spanner tighten by 1/4 turn. Then loosen the plug by 1/8 turn and re-tighten using plug spanner.*

## ENGINE OIL LEVEL

Check the engine oil level periodically.

1. Place the vehicle on centre stand on a flat surface. Wipe-off the surroundings of gauge oil level.
2. Remove the gauge and wipe it clean.
3. Fix the gauge back to its mounting hole. Do not thread in.
4. Take out the gauge and check the oil level. The level should be between minimum and maximum level marks of the gauge (shown in the figure).
5. If the oil is less than the minimum level, add 'TVS TRU4 SKUUTA oil (SAE 10W30 API-SL, JASO MB)' upto the maximum level mark.



6. Wipe out the oil traces with a clean cloth to prevent dust accumulation.
7. Assemble back the gauge oil level.

 **Caution**

*If the vehicle is driven with less engine oil, the engine components will be severely damaged.*

*Check the oil level as per the schedule to avoid costly damage. Do not fill excess oil may cause oil leak. Always use 'TVS TRU4 SKUUTA oil only (SAE 10W30 API-SL, JASO MB)'.*

### TRANSMISSION OIL - LEVEL

Check the transmission oil level periodically.

1. Place the vehicle on centre stand on a flat surface.
2. Wipe-off the surroundings of oil level screw.
3. Remove the transmission oil level screw along with a gasket from the rear end of crankcase L.
4. Check for the flow of oil from oil level hole.
5. If the level is less (if there is no oil flow), top-up with 'TVS TRU4 SKUUTA oil (SAE 10W30 API-SL, JASO MB)' till the oil just starts to flow out from the oil level hole.



6. Wipe out the oil traces with a clean cloth to prevent dust accumulation.
7. Replace the fiber washer while reassembling the oil level screw.

 **Caution**

*If the vehicle is driven with less transmission oil, the transmission components of engine will be severely damaged.*

*Check the oil level as per the schedule to avoid costly damage. Do not fill excess oil may cause oil leak. Always use 'TVS TRU4 SKUUTA oil only (SAE 10W30 API-SL, JASO MB)'.*

## BRAKES

### Front brake

You can observe a master cylinder (1) right side of the handle bar under the head lamp housing.

A caliper assembly (2) fitted to the fork leg L, a disc (3) on the front wheel and a high pressure hose (4) connecting the master cylinder and the caliper assembly.

1. Check the master cylinder brake fluid level through the view piece glass (A).
2. The brake fluid level always should be above the 'LOWER' mark (B) provided on the view piece glass of the master cylinder when the cylinder is parallel to ground.

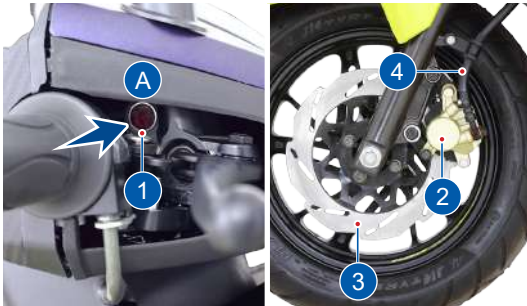

3. If the brake fluid level is below the mark or while applying brake if you feel the brake is more spongy or ineffective due to air entry, contact TVS Motor Company Authorised Main Dealer or Authorised Dealer for topping-up the brake fluid, air bleeding and other brake related inspections.



### Caution

*Master cylinder brake fluid level must be checked only when the master cylinder is parallel to the ground.*

### Brake pad wear indicator (Disc brake)

Check for the wear of brake pads visually. If the brake pads wear is found beyond the wear indicator groove as shown in the figure, replace the brake pads as a set with a new one.

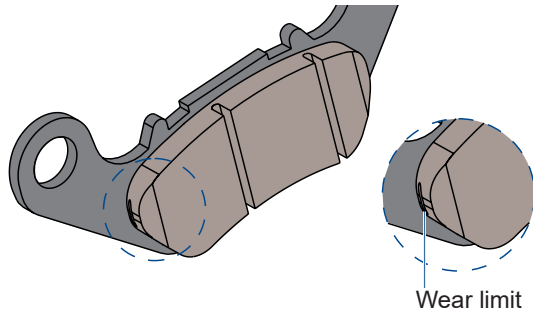

#### **Caution**

Replace the brake pads as a set, if the wear indicator shows beyond the wear limit.

#### **Warning**

Disc brake SBS cable need to be adjusted incase if rattling is found in both brake levers.

### Rear brake (Drum brake)

1. Measure the free play of the rear brake lever at the lever end as shown in the figure.
2. Free play of brake lever before the engagement of brake should be between 10 ~ 15 mm.
3. If the measured distance is more than the limit, adjust the nut provided at the rear wheel end to obtain the correct play.



#### **Warning**

Check front brake (drum brake type) and rear brake play periodically. However the brake play needs to be adjusted more frequently depending upon the usage.

- Turn the adjuster nut in clockwise direction for reducing free play or in anti-clockwise direction for increasing the free play.



### Note

Please remember that the rear brake lever free play adjustment to be done only after adjusting the front brake lever play incase of SBS type brake (Drum type).

### Brake shoe wear indicator (Rear brake)

When brake is applied, the wear limit indication pointer (1) on the rear brake cam lever should be within the wear limit indicator (2) on the crankcase LH.

In case the wear limit indication pointer (1) is going beyond wear limit indicator (2), index the lever to next slot with the help of Dealers to extend shoe life.

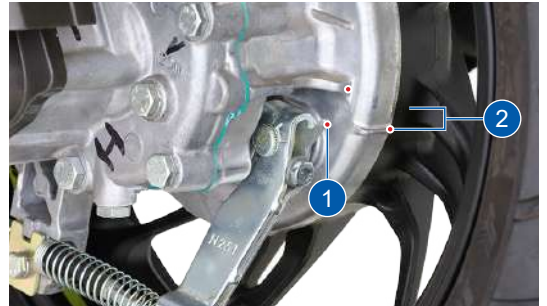

### Caution

Replace the brake shoes as a set, if the wear limit indicator shows beyond the wear limit even after indexing the lever.

## TYRES

### Tyre pressure

Check the tyre pressure atleast once in a week if not more frequently. Insufficient air pressure in the tyres not only hasten tyre wear, but also seriously affects the stability of the vehicle.

Under inflated tyres make smooth cornering difficult and over inflated tyres decreases the tyre contact with the ground which can lead to skidding and loss of control.

Be sure that the tyre pressure is within the specified limit at all times.

### Tyre pressure in cold condition:

	Solo	Dual
<b>Front</b>	1.69 kg/cm <sup>2</sup> (24 PSI)	1.69 kg/cm <sup>2</sup> (24 PSI)
<b>Rear</b>	1.97 kg/cm <sup>2</sup> (28 PSI)	2.53 kg/cm <sup>2</sup> (36 PSI)

### Tyre tread condition

Operating the vehicle with excessively worn tyres will decrease riding stability and can lead to loss of control. It is recommended to replace the tyre when the tyre wears off to the tyre wear indicator level (indicated by TWI (A) on the tyre).



### Warning

*The tyre inflation pressure in cold condition and the tyre tread condition are extremely important for the performance and safety of the rider. Check the tyres frequently for inflation pressure as well as the wear pattern on it. Use of a tyre other than the standard may cause instability.*

### **Tyre rotation direction**

While reassembling the tyre on the wheel rim, please ensure the following:

1. The front tyre (indicated by 'FOR FRONT FITMENT' on the tyre) should not be assembled to rear wheel rim.
2. The arrow mark on the tyre should match the actual direction of rotation of wheel (both front and rear wheels).

### **Tyre puncture**

Your scooter is fitted with a tubeless tyre on both front and rear wheel. In case of any puncture / tyre damage, it is advised to visit the nearest tyre manufacturer Dealer or the tyre repair shops who knows the repairing method of tubeless tyre.

It is not necessary to remove the tyre from wheel rim always to attend a puncture, Even though it there is need of tyre removal, it is strongly recommended to use a tyre removal / fitment machine. If at all, tyre levers needs to be used, the levers should be free from sharp edges. Care should be taken not to damage the tyres and rims.



### **Caution**

*The side walls of the tubeless tyre which in contact with the wheel rim are only seals the air inside the wheel assembly. Hence care should be taken not to damage the side walls of the tyres during removal / reassembly.*



## Tyre Maintenance Tips

### Inflation Pressure Check - Condition



**Within  
1 km**



**Within  
5 km**

### Note

*If vehicle is in hold condition for long time*

- *Need movement of vehicle to avoid particular spot of tyre not to touch the ground for more than week time.*
- *Inflation pressure should check on cold condition maximum travel time should not exceed more than 1 km.*
- *Weekly basis inflation pressure check helps to improve 10% of tread life & fuel efficiency.*



## FRONT WHEEL REMOVAL AND REASSEMBLY

1. Remove the axle nut (1) along with a washer.
2. Pull out the axle (2) along with a washer and take out a spacer from the left side of the wheel.
3. Place a support below the foot board to prevent vehicle from falling and lift the vehicle up.
4. Dislocate the wheel disc from caliper assembly and take out the wheel along with hub drive.
5. Reverse the procedure for reassembling. Ensure the proper seating of wheel disc in the caliper assembly and lug on fork leg R to the slot in the hub drive while reassembling.



## REAR WHEEL REMOVAL AND REASSEMBLY

1. Place the vehicle on the centre stand.
2. Hold the rear brake firmly and remove the wheel mounting nut (1) along with a washer.
3. Slightly tilt the vehicle and take out the wheel from the rear axle.
4. Reassemble the wheel in the reverse order of removal.

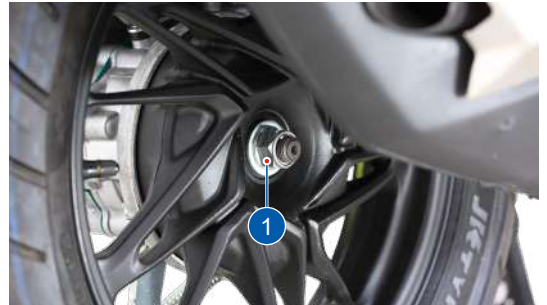

### **Caution**

*Always make sure, whenever the wheel is removed, the axle nuts are tightened properly to the specified torque.*

## STORAGE PROCEDURES

For storage of your scooter for longer period of over a month and above, we recommend to carry out the following steps:

1. Clean the vehicle thoroughly. Park the vehicle on centre stand.
2. Warm up the engine and drain engine oil and transmission oil. Store the oil, if new, in a dust free container.
3. Empty the fuel tank.
4. Remove the spark plug and feed in several drops of engine oil through spark plug hole. Crank the engine few times and reinstall the spark plug.
5. Remove the battery, store it away from direct sunlight and freezing temperatures.
6. Place a suitable support at the bottom of the foot board so that both the tyres are off the ground. This will ensure better tyre life.
7. Cover up the vehicle completely with a clean tarpaulin or any other suitable cover. Store the vehicle inside a garage or similar area to avoid damage due to dust and rain. Make sure that the storage area is well ventilated and free from any source of flame or spark.



### Caution

*Do not park the vehicle on a slope or soft ground or else it may fall down.*

*The exhaust system becomes hot after a run. Park the vehicle in a place where pedestrians or children are not likely to touch the vehicle.*

*During storage, the battery must be recharged at recommended charger if stored more than a month.*

## TAKING THE VEHICLE OUT OF STORAGE FOR REGULAR USE

1. Take the vehicle out of garage and clean it thoroughly.
2. Remount the battery after bench charging if required.
3. Fill the engine oil (TVS TRU4 SKUUTA oil - SAE 10W30 API-SL, JASO MB) and check the oil level using gauge oil level.
4. Fill the transmission oil (TVS TRU4 SKUUTA oil - SAE 10W30 API-SL, JASO MB) and check the oil level at the oil level screw.
5. Lubricate the parts as instructed in the periodic maintenance schedule.
6. Fill up fresh petrol in the fuel tank.
7. Check and inflate the tyres to the specified tyre pressure.
8. Check and correct the points mentioned in page No. 88.
9. Turn the ignition switch to 'ON' position. Retract the side stand if the vehicle is parked on side stand. Start the vehicle and ride out.



### Caution

*Avoid using alkaline solution like detergent soaps for washing. This may damage head lamp and other lamp assemblies.*

## RECOMMENDED TIPS WHEN TAKING A LONG TRIP OF MORE THAN 500 KM:

- A) Please keep the following items for use in case of emergency:
1. Tool kit complete.
  2. Recommended spark plug one number.
  3. Turn signal lamp bulb each one.
  4. Throttle and rear brake cable each one.
  5. First aid kit.
- B) Precautions to be taken for the journey:
1. Ensure engine oil and transmission oil are up to the level.
  2. Adequate fuel in the fuel tank.
- C) Check your scooter for the following:
1. Tightness of all bolts and nuts with correct torque value.
  2. Fitness of tyres / tyre pressure / tread depth.
  3. All bulbs, indicators and horn functioning.
  4. Smooth functioning of all cables and their free play.
  5. Smoothness of steering operation.
  6. Front / rear brake function and rear brake lamp working.

7. Front fork for any abnormality.
8. Spark plug gap and condition of spark plug.
9. Air filter element cleanliness.
10. Lubrication of all items mentioned in the periodic maintenance schedule.
11. Any other job as necessary.
12. Have your vehicle checked at any TVS Motor Company Authorised Main Dealer or Authorised Dealer.



### Caution

*Long journey are to be taken only after the running-in period of 1000 km.*

**TVS Motor Company Limited ('the Company') give this warranty with respect to the TVS NTORQ 125 XT manufactured by the Company.**

While the Company has taken every care to maintain quality in the manufacture of the TVS NTORQ 125 XT, the above said warranty is subject to other terms of warranty:

During 5 years from the date of purchase or during the first 50,000 km of run for the vehicle in the hands of original retail purchaser, whichever is earlier, the parts of the vehicle covered under warranty which prove to the satisfaction of the Company to have a manufacturing defect will be repaired or replaced free of cost.

The Company's obligation under this warranty is limited to repairing or replacing, free of cost, those parts of the vehicle which upon examination by the Company may prove to the Company's satisfaction to have a manufacturing defect, and in such cases the Company's decision either to repair or replace the affected parts will be final. In the event of replacement of parts, the Company also reserves the right to use parts of the same brand as the affected parts or any other brand which is used by the Company in the course of manufacture. All parts replaced under this warranty will become the property of the Company and must be returned to the company.

**Limitations of Warranty:**

This warranty shall not apply to following condition:

1. Any natural wear and tear, including without limitation, aging.
2. Warranty claims on proprietary items such as tyres, tubes and batteries etc., should be preferred by the user directly on the respective manufacturer, as per their warranty terms and the Company shall not be liable in any manner in respect to the same.
  - Battery warranty for "MF type (Maintenance Free)" is applicable for a period of 21 months from the date of charging or 18 months from the date of sale or 20,000 kms, whichever is earlier.
  - Battery warranty for "Lead Acid type" is applicable for a period of 15 months from date of charging or 12 months from date of sale or 10000 kms whichever is earlier.
3. Parts repaired or replaced under this warranty are warranted only throughout the remainder of the original warranty period.



4. The Company is not liable for any delay in servicing due to reasons beyond the control of the Company or any of its Authorised Main Dealers / Authorised Dealers.
5. In any event, the Company is not liable for indirect, remote, incidental or consequential damages.
6. The Company may make any modification or improvement to vehicles in future production at any time without prior notice and without any obligation to install the same on vehicles previously dispatched for sale.
7. Any claim under this warranty will lie only when the customer:
  - takes his vehicle to an Authorised Main Dealer / Authorised Dealer of the Company and reports the problem he / she felt in the vehicle to enable the Authorised Main Dealer / Authorised Dealer to inspect the same and assess the cause for the reported problems.
  - produces to such Authorised Main Dealer / Authorised Dealer the Service Handbook for the concerned vehicle for verification of relevant details.
8. This is the only warranty given by the Company for the TVS NTORQ 125 XT. No employee, Dealer or other person is authorised to extend or enlarge this warranty.

 **Warning**

*Modifications to this vehicle not approved by the TVS Motor Company may cause loss of performance and render it unsafe for use and disqualifies for warranty coverage also.*

**Following Toll Free numbers can be contacted for battery related queries if any.**

Incase of EXIDE battery, call :- 1800 103 5454

Incase of AMCO battery, call :- 1800 425 0096

Incase of TATA GREEN battery, call :- 1800 419 8888

Incase of AMARON battery, call :- 1800 425 5858

**Following Toll Free numbers can be contacted for Tyre related queries if any.**

Incase of TVS Srichakra, call :- 04522443300

Incase of JK tyre, call :- 18002581100

Incase of Maxxis tyre, call :- 1800 532 2888

## List of parts not covered under warranty

ITEM	WHAT TO CHECK FOR
Normal Maintenance Operations	Engine tune-up, decarbonizing, fuel system cleaning, oil changes, head light focusing, fastener retightening, ignition timing, clutch and brakes as well as other normal adjustments.
Wear and Tear Items	Chain, sprockets, clutch and brake linings, fasteners, shims, washers, oil seals, gaskets, O' rings and spokes etc.
Electrical	Bulbs , fuse, DRL, AHO
Service Maintenance Parts	Oil filters, spark plug, air filter, SAI filter, oils and brake fluid
Rubber, Rexine and Plastic Items	All hoses, pipes and plastic aesthetics
Proprietary Items	<p>Battery, tyres and tubes (the warranty terms are subject to our agreement with proprietary OEM)</p> <p>(Battery warranty for "MF type (Maintenance Free)" is applicable for a period of 21 months from the date of charging or 18 months from the date of sale or 20,000 kms, whichever is earlier).</p> <p>(Battery warranty for "Lead Acid type" is applicable for a period of 15 months from date of charging or 12 months from date of sale or 10000 kms whichever is earlier).</p>
Others Factors	Parts of the vehicle getting affected due to atmospheric effect / environmental factors (rusting, paint peel off etc.). However, depending on the vehicle usage condition, warranty would be accepted up to 2 years from the date of purchase.
	Parts of the vehicle which have been tampered with, altered, repaired or replaced by persons not authorised by the Company and which in the sole judgement of the Company affect the performance of the vehicle.

## List of parts not covered under warranty

ITEM	WHAT TO CHECK FOR
Others Factors	Parts which are used in conjunction with parts not made or recommended by the Company.
	Parts suffering damage or resultant damage by accident, misuse, negligent treatment, use of bad quality lubricants or impure fuel or by omission to follow the guidance and instructions contained in this owner's manual.
	Vehicles on which engine number or chassis number is deleted, defaced or altered.
	Vehicles on which any warranty service including scheduled paid service is not availed when it falls due (at TVS Motor Company Authorised Main Dealer / Authorised Dealer).
	<p>Vehicles sold or transferred by original retail purchaser.</p> <p>Vehicles used for racing or any competition or used otherwise than for ordinary personal transportation. Vehicles attached with side cars etc.</p> <p>Vehicles which have been taken out of India.</p> <p>Vehicles affected by natural calamities like flood, earthquake, tsunami, storm etc.,.</p>
	If the vehicle has been used for commercial purpose like taxi or used for rental or hiring or any other purpose other than regular personal transportation.



## SERVICE INFORMATION

There are seventeen services for TVS NTORQ 125 XT during warranty period. Of these, first four services are free services for which labour charges are free. In addition to these four free services, we have a scheme of thirteen pay services. For keeping the maintenance track of your vehicle, free and pay service record sheets are attached in the Service Handbook given to you during the time of your vehicle purchase. Please have the relevant record sheet filled by the Dealer who is carrying out the maintenance service.

For availing any of the warranty services, please take your vehicle and your Service Handbook to any of our Authorised Main Dealers or any of our Authorised Dealer. After effecting the service the Authorised Main Dealer or the Authorised Dealer will affix their stamp on the last column of free or pay service record sheet of Service Handbook for your record and reference. An OTP would be sent to customer's registered mobile number. The same to be shared with the servicing Dealer on or before vehicle delivery.

Periodic maintenance always helps good performance of an automobile and our services are planned to keep your TVS NTORQ 125 XT performing good. **Please note that carrying out the services for your vehicle at scheduled intervals at any of the TVS Motor Company Authorised Main Dealer / Authorised Dealer is necessary for availing of warranty.** And please also remember that, after the services are over, periodic servicing of your vehicle at appropriate intervals, depending upon its extent of use, will keep your vehicle at its best level of performance.

In case you need any clarification or assistance, please feel free to write to us mentioning the frame number, engine number and date of purchase of your vehicle also the name and place of the Authorised Main Dealer / Authorised Dealer from whom you bought the vehicle and getting it serviced.

### Service Department

**TVS MOTOR COMPANY LIMITED**

**P.O. Box No. 4, Harita, Hosur - 635 109,**

**TAMILNADU, INDIA.**

**Toll free no:- 1800-258-7111**

**Planned Service Schedule (kms or month whichever of the two occurs early)\***

Sl.No.	Service	Type	Kms	Months
1	1st Service	Free	500 ~ 750	2
2	2nd Service		2500 ~ 3000	4
3	3rd Service		5000 ~ 6000	8
4	4th Service		8500 ~ 9000	12
5	5th Service	Pay	11500 ~ 12000	16
6	6th Service		14500 ~ 15000	20
7	7th Service		17500 ~ 18000	24
8	8th Service		20500 ~ 21000	28
9	9th Service		23500 ~ 24000	32
10	10th Service		26500 ~ 27000	36
11	11th Service		29500 ~ 30000	40

Sl.No.	Service	Type	Kms	Months
12	12th Service	Pay	32500 ~ 33000	44
13	13th Service		35500 ~ 36000	48
14	14th Service		38500 ~ 39000	51
15	15th Service		41500 ~ 42000	54
16	16th Service		44500 ~ 45000	57
17	17th Service		47500 ~ 48000	60

### Note

**Free service enables the customer to avail the service at free of labour charges. Charges for the pay service should be borne by the customer. Cost of engine oil, periodic maintenance parts, filter, brake fluids, all types of greases, petroleum jelly, distilled water, chain cleaner, lubricants, coolants, cleaning cloths for both free and paid services are chargeable to the customer.**

*\* Please remember that, after the above schedule, periodic servicing of your vehicle at appropriate intervals, depending upon its extent of use, will keep your vehicle at its best level of performance.*

**MANUFACTURER** : TVS MOTOR COMPANY LIMITED  
P.B. No1, Bythahalli, Kadakola post, Mysore - 571 311, India.

### ENGINE

Type : Single cylinder, 4 stroke, fuel injection, air cooled, spark ignition engine

Cylinder bore : 53.5 mm

Stroke : 55.5 mm

Piston displacement : 124.8 cc

Compression ratio : 10.3 : 1

Air filter : Dry paper filter with dry foam

Oil filter : Wire mesh

Lubrication system : Forced wet sump

Maximum power in kW : 6.9 @ 7000 rpm

Maximum torque in Nm : 10.5 @ 5500 rpm

Maximum speed : 94 km / h

Engine idling rpm<sup>†</sup> : 1500 ± 100 rpm

Starting system : Electric starter / Kick starter\*

Emission norms : BSVI

<sup>†</sup> Under warm condition

\* Optional accessory can be fitted on chargeable basis.

### TRANSMISSION

Clutch : Dry - Centrifugal clutch

Primary transmission : CVT (Continuos Variable Transmission)

Primary reduction : 2.65 to 0.8

Secondary reduction : 9.085

### CHASSIS

Overall length : 1861 mm

Overall width : 710 mm

Overall height : 1164 mm

Ground clearance : 155 mm (unladen)

Wheel base : 1285 mm

Kerb weight (with toolkit and 90% of fuel) : 110 kg

Pay load : 130 kg

Maximum laden weight : 240 kg

Frame : Under bone tubular frame

Front suspension : Telescopic hydraulic

Rear suspension : Toggle link, gas filled hydraulic damper

## TYRE

### Tyre size

Front	: 100/80 - 12 56L Tubeless
Rear	: 110/80 - 12 61L Tubeless

### Tyre pressure

Front	: 1.69 kg/cm <sup>2</sup> (24 PSI)
Rear - solo	: 1.97 kg/cm <sup>2</sup> (28 PSI)
Rear - dual	: 2.53 kg/cm <sup>2</sup> (36 PSI)

## BRAKES

Front	: 220 mm dia Disc (hand operated)
Rear	: 130 mm dia Drum (hand operated)

## ELECTRICAL

Ignition system	: ECU controlled ignition
Spark plug	: BOSCH - UR5KCW / CHAMPION - RG8MC4
Spark plug gap	: 0.9 ~ 1.0 mm / 1.0 ~ 1.1 mm
Battery type	: 12V, 4Ah / 3Ah MF battery
Generator	: Fly wheel magneto 12V, 130W

Head lamp with AHO	: 12V, LED
DRL / Position lamp	: 12V, LED
Tail / brake lamp	: 12V, 1/2W LED
Turn signal lamp	: 12V, 10W x 4
Number plate lamp	: 12V, 5W
Instrument cluster	: Hybrid cluster (TFT & LCD)
Horn	: 12V, 2.5A DC
Fuse	: 15A x 1 (Blade type) : 10A x 2 (Blade type)



### Caution

*Using the bulb other than the specified rating can result in overloading of the electrical system or premature failure of the bulb.*

## CAPACITIES

Fuel tank capacity <sup>#</sup>	: 5.8 l
Fuel	: BS VI petrol with minimum RON 91 (containing upto 10% of ethanol by volume)
Engine oil grade	: TVS TRU4 SKUUTA oil (SAE 10W30 API-SL, JASO MB)
Engine oil capacity	: 880 ml (during regular service) 930ml (incase of disassembly)
Transmission oil capacity	: 120 ml (during regular service) 130ml (incase of disassembly)
Front fork oil grade	: Gabriel Premium front fork oil
Front fork oil capacity	: 91 ± 1 cc per leg
Brake fluid	: TVS Girling DOT 3 / DOT 4

### Note

*Specifications are subject to change without notice.*

<sup>#</sup> The fuel tank is not a measuring instrument and the capacity of fuel tank may slightly vary from the indicated capacity.



**Drive In.**

**Drive Out.**



**Say bye-bye to waiting time  
for servicing your bike.**

**Get your vehicle serviced in 1 hour at no additional cost. Contact your nearest Dealership for details.<sup>†</sup>**

<sup>†</sup>Facility available at selected Dealerships only. Terms and conditions apply





# Busy Life? Easy Servicing!

Now, service your bike anywhere, anytime.

- ★ Service the vehicle at your door step.
- ★ Available for regular maintenance or breakdown service only.
- ★ Offered at nominal convenience charges.

Contact your nearest Dealership for details.<sup>†</sup>

<sup>†</sup>Facility available at selected Dealerships only. Terms and conditions apply





# Busy Life? Easy Servicing!

Now, service your bike anywhere, anytime.

- ★ Service the vehicle at your door step.
- ★ Available for regular maintenance or breakdown service only.
- ★ Offered at nominal convenience charges.

Contact your nearest Dealership for details.<sup>†</sup>

<sup>†</sup>Facility available at selected Dealerships only. Terms and conditions apply



## GENERAL INFORMATION

Dear Customer,

It is mandatory under the Motor Vehicles Act to insure all motor vehicles. No motor vehicle can be used in a public place without a valid policy of insurance issued by an authorised insurer. Driving a motor vehicle without any such insurance is an offense under Motor Vehicles Act.

To assist our Customers on their insurance requirements such as the prompt issue and renewal of policies as well as expeditious settlement of claims if any, our preferred insurers are:







**TVS MOTOR COMPANY LIMITED**

**P.B. NO. 4, HARITA, HOSUR - 635 109, TAMIL NADU, INDIA.**

**TELEPHONE: +91 (4344) 276780 | FAX: +91 (4344) 277311/276878**

**WEBSITE: [WWW.TVSMOTOR.COM](http://WWW.TVSMOTOR.COM) | TOLL-FREE NO.: 18004252077**